



Aquarea T-CAP Hydraulic M Series with control module.

100% hydraulic solution for domestic hot water, heating and cooling from a stand-alone outdoor unit with advanced functionality.

1. Employs natural refrigerant R290 with GWP 3
2. Up to 75°C water outlet down to -15°C outdoor*
3. Aquarea T-CAP, high performance whatever the climate: Keeping heating capacity down to -20°C at 35°C water outlet / Reliable outdoor units with Panasonic compressor, operating down to -28°C outdoor**
4. Quiet operation: Only 29dB(A) sound pressure at 5m***
5. Compatible with Panasonic Comfort Cloud App and Aquarea Service Cloud

* Down to 15 °C outdoor for 20, 25 and 30kW models.

** Down to -25°C outdoor for 20, 25 and 30kW models.

*** Sound pressure calculation for WH-WXG12ME5, free standing, A +7°C, W 35°C in Quite mode

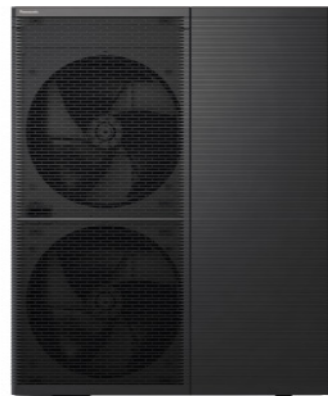

AQUAREA

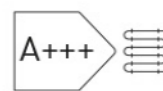
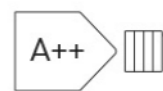

A revolution in design, efficiency and connectivity

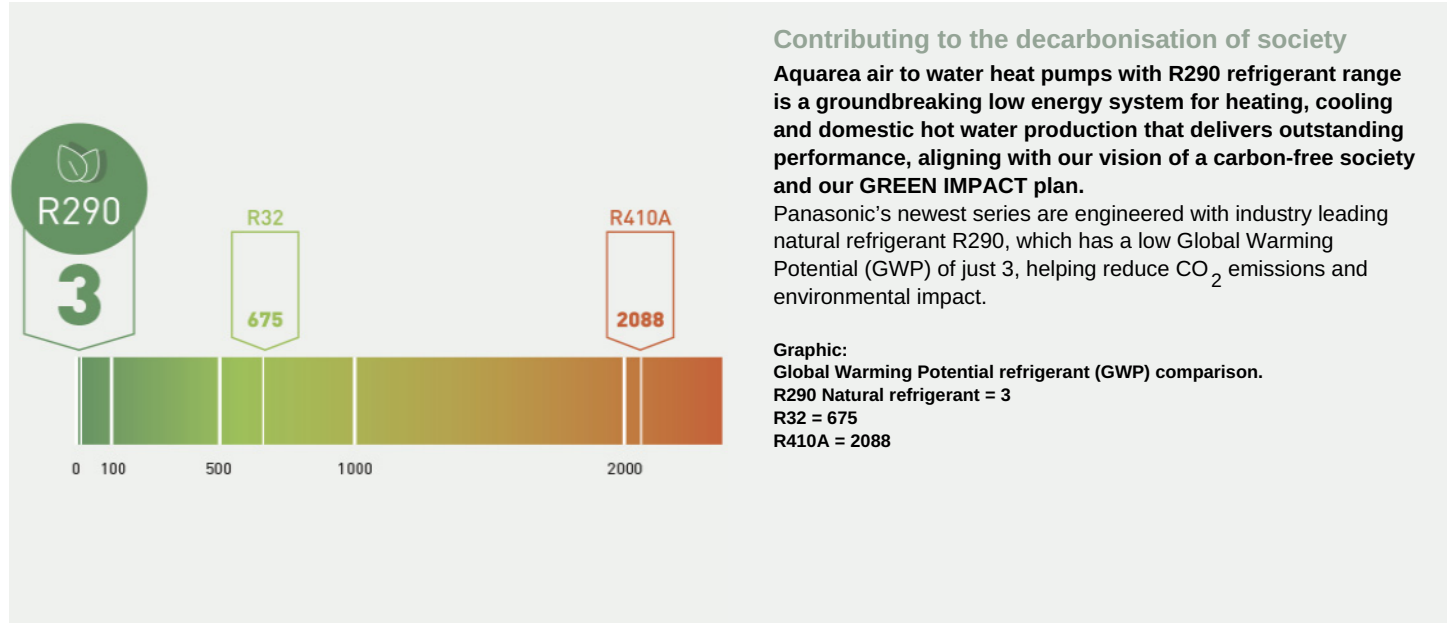

Contributing to the decarbonisation of society

Aquarea air to water heat pumps with R290 refrigerant range is a groundbreaking low energy system for heating, cooling and domestic hot water production that delivers outstanding performance, aligning with our vision of a carbon-free society and our GREEN IMPACT plan.

Panasonic's newest series are engineered with industry leading natural refrigerant R290, which has a low Global Warming Potential (GWP) of just 3, helping reduce CO₂ emissions and environmental impact.

Graphic:
Global Warming Potential refrigerant (GWP) comparison.
R290 Natural refrigerant = 3
R32 = 675
R410A = 2088



Introducing T-CAP, M Series the latest generation of Aquarea air to water heat pumps with R290

Flexible installation, suitable for retrofit and new buildings.

Thanks to its new, modular concept, the outdoor unit can function independently with just an indoor remote control, for those seeking basic functionalities. Homeowners can opt for enhanced functionality by incorporating the more advanced control module or selecting between the range of indoor units.



A revolution in design

The outdoor unit. With an anthracite grey colour which dresses the entire range, is designed to harmonize with architecture and the environment with a quiet operation.

The indoor unit. Designed to blend into your interior space effortlessly. In premium white, faithful to the Aquarea spirit, underlined by the seamlessly integrated controller which provides a sleek black band across the unit.

* Awards for 9, 12 and 16kW Models (Single and Three phase)



Aquarea T-CAP, high performance whatever the climate



Aquarea T-CAP, high performance whatever the climate

Aquarea T-CAP outdoor units are highly reliable thanks to the quality of all components, including the new compressor with injection technology, developed and manufactured by Panasonic, that can work in outdoor temperatures as low as -28°C ¹⁾.

Specially designed to work under severe outdoor conditions, Aquarea T-CAP can work in outdoor temperatures as low as -28°C ¹⁾ and maintain the rated heating capacity even at -20°C ²⁾ outdoor temperature, without requiring an electrical heater.

1) Down to -25°C outdoor for 20, 25 and 30kW models. 2) At 35°C flow temperature.

a. Aquarea T-CAP Heat Pump. b. Backup heater. c. Standard heat pump. d. Required heating load. e. Power (kW)
Other heat pumps may require oversizing plus additional backup heater support.

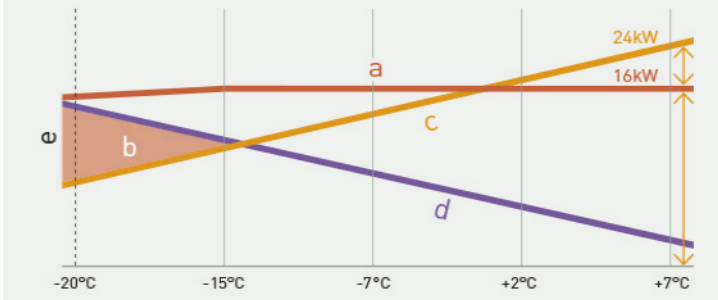

For retrofit and new buildings

The wide Aquarea T-CAP range ensures the most appropriate choice for your home - whatever the size.

Aquarea T-CAP easily replaces old boilers or manages bivalent installations and is ideal for supplying radiators, fan coils or underfloor heating up to 75°C, even at -15°C ¹⁾ outside. It can even supply hot water at 55°C when the outside temperature is -28°C ²⁾.

1) Down to 15°C outdoor for 20 to 30kW models. 2) Down to -25°C outdoor for 20 to 30kW models.

a. Water temperature. b. Outdoor temperature.

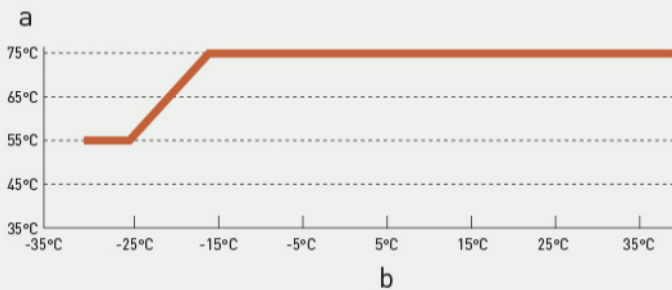

High energy efficiency in heating

The Aquarea M Series saves energy and significantly reduces operating cost by achieving the highest ErP energy rating. Aquarea M Series can reach a domestic hot water temperature of up to 65°C without the use of the electric heater, so the tank sterilization can be performed with the heat pump operation for further energy savings.

* Rating conditions: Heating: Inside air temperature: 20°C Dry Bulb / Outside air temperature: 7°C Dry Bulb / 6°C Wet Bulb. Conditions: Water input temperature: 30°C / Water output temperature: 35°C. Energy rating for WH-WXG12ME8.

High energy rank for low/medium temperature applications.

ErP 35°C / 55°C.

Energy efficiency class up to A+++/A++ in a scale from A+++ to D.

Maximising hot water comfort

- Up to 40% more tap water with a higher tank temperature setting to save space
- New domestic hot water circulation mode for instant availability of hot tap water
- During sterilisation, the domestic hot water circulation mode is activated to ensure sterilisation of the water pipes

The hot water in the pipes recirculates back to the tank at set intervals during the set time period, ensuring instant hot water for the end user.

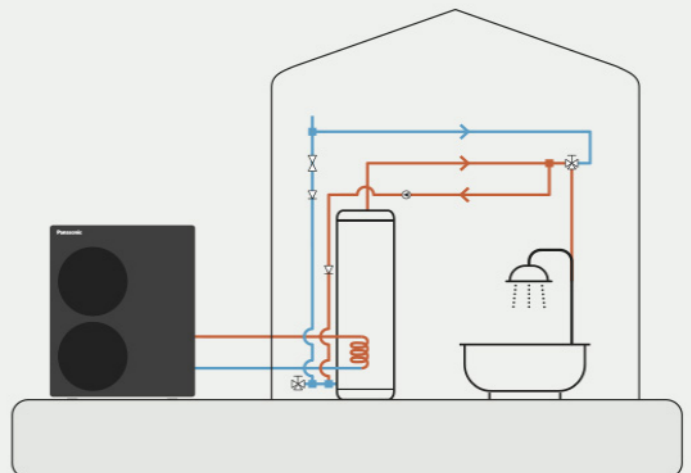

Harmony between technology and home

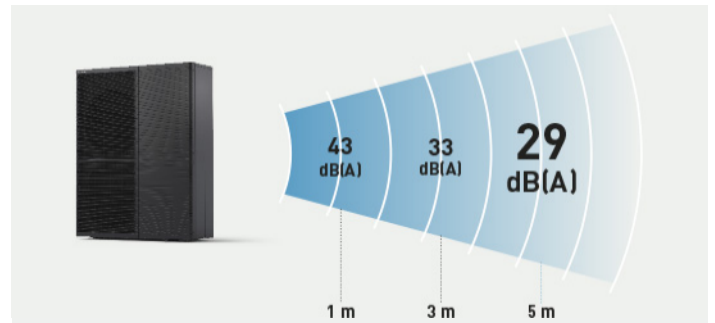

Quiet operation. Panasonic's unique low noise architecture

The compressor, which is a major source of noise, is equipped with a double-bottomed structure to provide a safe, quiet structure that does not disturb neighbours in crowded residential areas.

* Sound pressure calculation for WH-WXG12ME8, free standing, A +7°C, W 35°C in Quite mode 3.

Reliable technology

Aquarea T-CAP M Series outdoor units are equipped with a Panasonic R290 scroll compressor with injection technology, manufactured in-house, that can work in outdoor temperatures as low as -28°C*.

The outdoor heat exchanger is protected with a Bluefin treatment for harsh ambient conditions.

Great serviceability

Cutting-edge outdoor unit design keeps the PCB in a safe and accessible location.

Aquarea M Series safety optimisation*.

- 1) Non-flammable control box
- 2) Power box cable gland with sealed connections
- 3) Air/refrigerant separator

* Applies to 9-12-16kW.

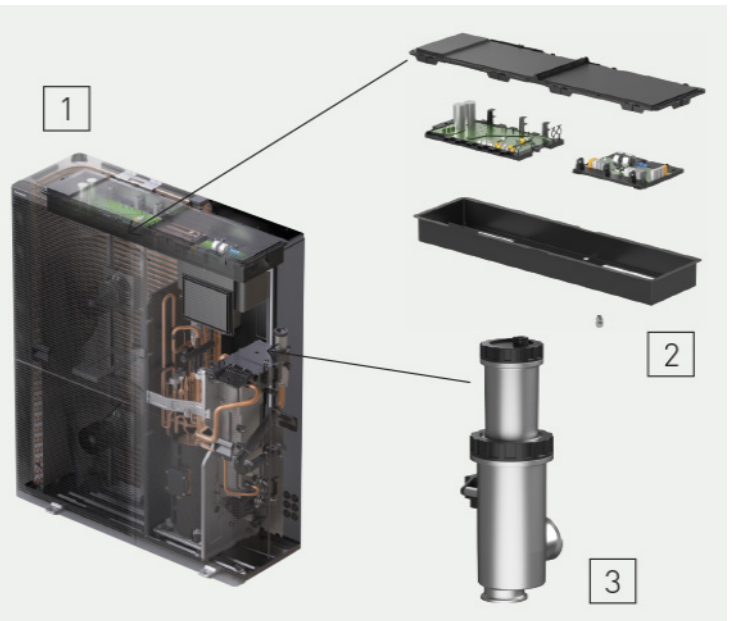

Big Aquarea T-CAP M Series for centralised heating and DHW installations



Big Aquarea T-CAP M Series, the ideal solution for centralised heating and DHW installations

The new Big Aquarea M Series offers a flexible, compact and energy-efficient solution for central heating and/or domestic hot water installations in multi-family or commercial buildings.

The solution is suitable for both new buildings and retrofits, as it offers a more sustainable alternative to traditional fossil fuel heating systems and it can be easily integrated with existing water system such as fan coils, floor heating or domestic hot water tanks.



Big Aquarea T-CAP M Series, the solution for multi-family or commercial buildings

- Units from 20 to 30kW, up to 300kW in cascade
- Easy replacement of other heating sources
- Flexible control options: remote control only or control module for enhanced functionality
- Seamless Modbus integration
- Designed to blend with architecture and environment

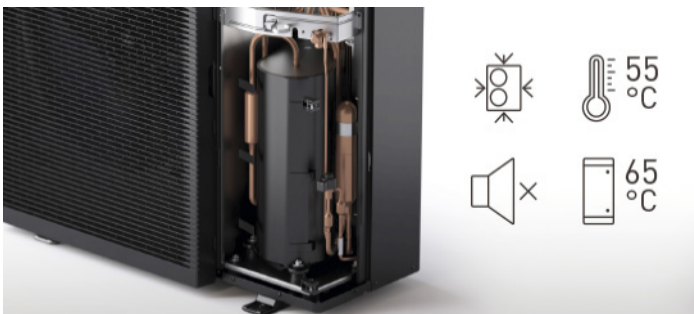

Keypoints

- Compact solution with small footprint
- Keeping capacity at 55°C water outlet down to -15°C outdoor.
- Quiet operation
- Panasonic Inverter compressor
- DHW at 65°C with compressor only

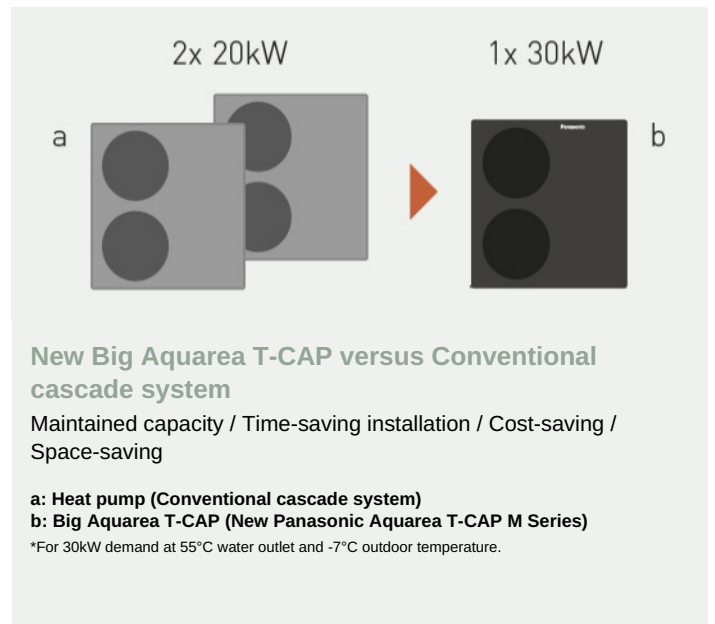

Aquarea M Series gives you even more



Remote controller designed in harmony

Remote controller designed in harmony with the whole system, with optimised user interface and improved features.

Smart bivalency: Cost effective bivalent mode with power tariff logic.

Optimised user interface: Each touch point designed in harmony, with optimised user interface across the range.



Dual controller system

A dual controller system, for independent control of two zones, within the home.

a: Zone 1: 18°C - b: Zone 2: 20°C.



BMS integration

Aquarea heat pumps can be integrated into Modbus or KNX projects with an optional accessory, allowing comprehensive bi-directional monitoring and control of all operating parameters.



Additional interface connection port

Enhanced connectivity provided by a second interface connection port (CN-CNT) when the outdoor unit is connected to the control module or an indoor unit.

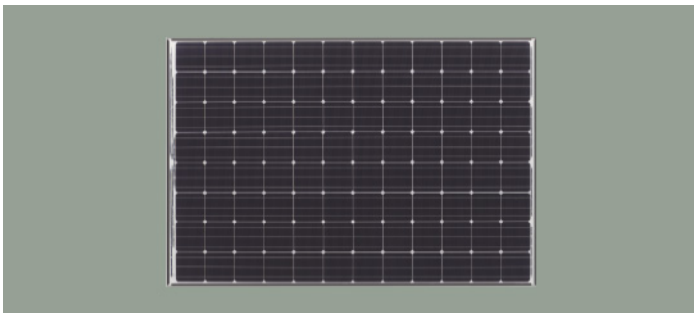

Aquarea + PV panels

Aquarea heat pumps can synchronise with PV panels, using the optional PCB CZ-NS5P or CZ-NS4P. Thanks to this feature, demand of heating, cooling and domestic hot water production is adapted to the PV panel production.



Smart Grid Ready

Aquarea heat pumps in combination with the optional PCB CZ-NS5P or CZ-NS4P hold the SG Ready function, allowing the heat pump to be connected in an intelligent grid control.

*J series or later

Home connectivity and energy management systems

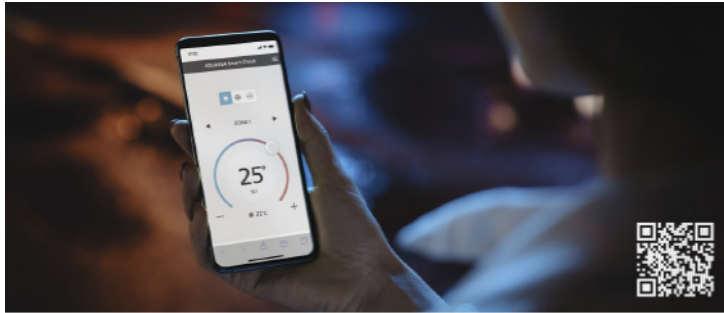

Panasonic Comfort Cloud App

The IoT solution for your heating and cooling systems to help maximize comfort while managing energy consumption.

The Panasonic Comfort Cloud App enables you to conveniently manage and monitor the Aquarea range of heating, cooling and hot water functions from just one mobile device. Also, energy monitoring is possible allowing opportunity to learn how to reduce the operating cost even more.

Included internet adapter for Wi-Fi and LAN connection

<https://demo.aquarea-smart.panasonic.com>



Aquarea Service Cloud

The real remote maintenance made simple.

Aquarea Service Cloud is an advanced service that allows your service provider to take care of your heating system remotely. It saves time and money and offers the quickest service and solutions for your heat pump.

Accurate monitoring and maintenance expands the system's lifespan and guarantees a higher Return On Investment for your heat pump.



Convenience and support

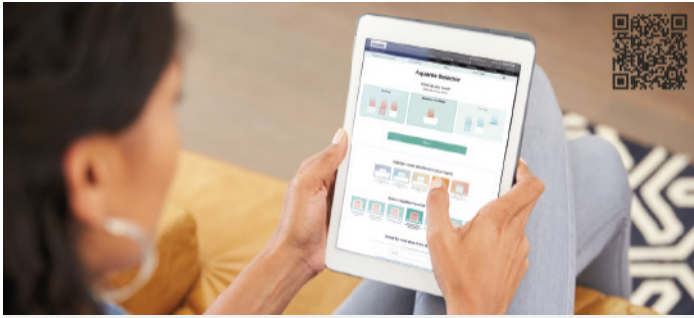

Aquarea Quick Selector

Helping you to find the Aquarea Heat Pump for your home in just a few clicks!

<https://aircon.panasonic.eu/visit/selection-tool/>



AR Heat Pump Viewer

This tool allows you to see how a Panasonic Aquarea Heat Pump looks in a home, utilising augmented reality.

<https://www.aircon.panasonic.eu/visit/ar-aquarea/>

Aquarea+ get the most out of your Aquarea Heat Pump

Learn how to use and program your new Aquarea.

In this site, you will find useful information that will allow you to operate your Panasonic Aquarea system to provide heating, cooling & hot water in the most efficient and cost effective way. Discover Panasonic Comfort Cloud App, the IoT solution for your heating and cooling systems to help maximize comfort while managing energy consumption.

<https://aquarea.panasonic.eu/plus>

Aquarea Service+. A window to tranquility

Why choose our Aquarea Service+?

- 1. Our service technicians are experts in Aquarea aerothermics.**
- 2. We diagnose faults remotely and avoid unnecessary technical support visits.**
- 3. IoT technology embedded in your Aquarea system.**

How to choose your right service package?

Aquarea Service+ Premium: Labour & travel costs included · Free Panasonic Spare parts · Service support within 24h including weekends · Priority support hotline 24/7 · On site annual maintenance.

Aquarea Service+ Smart: Daily diagnosis check · Service support within 24h including weekends · Priority support hotline 24/7 · On site annual maintenance.

Aquarea Service+ Comfort: On site annual maintenance · Priority support hotline.

<https://shop.aircon.panasonic.eu/>

Product and accessories

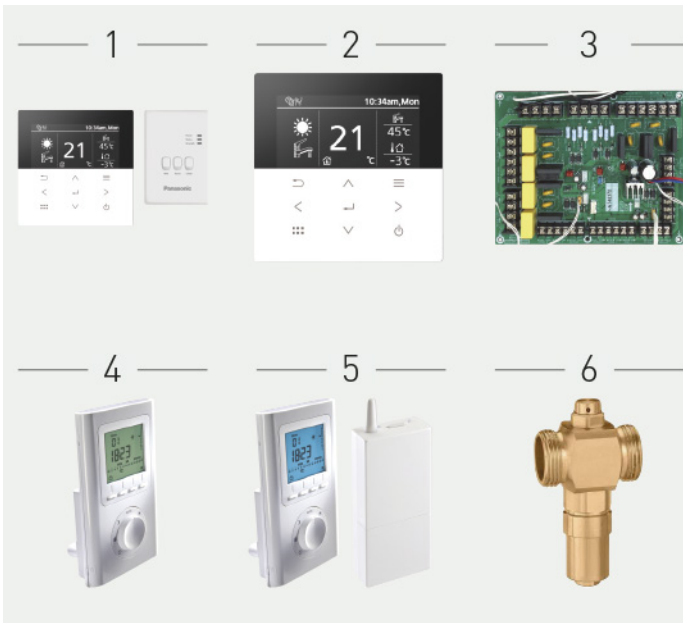

Accessories

1. CZ-RTW2TAW1C	Remote controller with Wi-Fi adapter (required for stand-alone outdoor units). M Series
2. CZ-RTW2	Optional remote controller for 2 zone control. M Series
3. CZ-NS7P	PCB for advanced functions. M Series control module
4. PAW-A2W-RTWIRED	Room thermostat
5. PAW-A2W-RTWIRELESS	Wireless LCD room thermostat
6. PAW-A2W-AFVLV-1	1 antifreeze valve. It is required to order 2 valves per system

Combination table

		Outdoor unit							
		Heating capacity							
		1φ		3φ					
		9,0 kW	12,0 kW	9,0 kW	12,0 kW	16,0 kW	20,0 kW	25,0 kW	30,0 kW
Indoor unit: Control module		WH-WXG09ME5	WH-WXG12ME5	WH-WXG09ME8	WH-WXG12ME8	WH-WXG16ME8	WH-WXG20ME8	WH-WXG25ME8	WH-WXG30ME8
1φ	WH-CME5	✓	✓	—	—	—	—	—	—
3φ	WH-CME8	✓	✓	✓	✓	✓	—	—	—
3φ	WH-CME8L	—	—	—	—	—	✓	✓	✓

T-CAP stand-alone outdoor M Series with control module 1 phase - 3 phase · R290

T-CAP stand-alone outdoor M Series with control module 1 phase - 3 phase · R290		SINGLE PHASE		THREE PHASE					
		9 kW	12 kW	9 kW	12 kW	16 kW	20 kW	25 kW	30 kW
		WH-WXG09ME5	WH-WXG12ME5	WH-WXG09ME8	WH-WXG12ME8	WH-WXG16ME8	WH-WXG20ME8	WH-WXG25ME8	WH-WXG30ME8
Outdoor unit									
Heating capacity (A +7°C, W 35°C)	kW	9,00	12,00	9,00	12,00	16,00	20,00	25,00	30,00
COP (A +7°C, W 35°C)		5,23	5,06	5,23	5,06	4,89	4,80	4,50	4,40
Heating capacity (A +7°C, W 55°C)	kW	9,00	12,00	9,00	12,00	16,00	20,00	25,00	30,00
COP (A +7°C, W 55°C)		3,24	3,23	3,24	3,23	3,20	3,18	3,00	3,00
Heating capacity (A +2°C, W 35°C)	kW	9,00	12,00	9,00	12,00	16,00	20,00	25,00	30,00
COP (A +2°C, W 35°C)		3,81	3,54	3,81	3,54	3,30	3,39	2,80	2,50
Heating capacity (A +2°C, W 55°C)	kW	9,00	12,00	9,00	12,00	16,00	20,00	25,00	30,00
COP (A +2°C, W 55°C)		2,54	2,42	2,54	2,42	2,37	2,08	1,97	1,95
Heating capacity (A -7°C, W 35°C)	kW	9,00	12,00	9,00	12,00	16,00	20,00	25,00	30,00
COP (A -7°C, W 35°C)		3,45	3,00	3,45	3,00	2,53	2,48	2,36	2,33
Heating capacity (A -7°C, W 55°C)	kW	9,00	12,00	9,00	12,00	16,00	20,00	25,00	30,00
COP (A -7°C, W 55°C)		2,35	2,17	2,35	2,17	1,97	1,90	1,80	1,49
Cooling capacity (A 35°C, W 7°C)	kW	9,00	9,00	9,00	9,00	9,00			
EER (A 35°C, W 7°C)		3,61	3,61	3,61	3,61	3,61			
Cooling capacity (A 35°C, W 18°C)	kW	9,00	12,00	9,00	12,00	16,00			
EER (A 35°C, W 18°C)		5,26	5,26	5,26	5,26	5,26			
Heating average climate. Seasonal energy efficiency (W 35°C / W 55°C)	SCOP	4,96 / 3,57	5,00 / 3,46	4,96 / 3,57	5,00 / 3,46	4,20 / 3,31	4,36 / 3,59	4,25 / 3,57	3,95 / 3,46
Heating average climate. Seasonal energy efficiency (W 35°C / W 55°C)	ηs %	195 / 140	197 / 135	195 / 140	197 / 135	168 / 129	171 / 141	167 / 140	155 / 135
Heating average climate. Energy class (W 35°C / W 55°C) (1)	A+++ to D	A+++ / A++	A+++ / A++	A+++ / A++	A+++ / A++	A+++ / A++	A+++ / A++	A+++ / A++	A+++ / A++
Heating warm climate. Seasonal energy efficiency (W 35°C / W 55°C)	SCOP	6,47 / 4,34	6,47 / 4,34	6,47 / 4,34	6,47 / 4,34	5,88 / 4,09	5,37 / 4,07	5,22 / 4,14	4,93 / 4,01
Heating warm climate. Seasonal energy efficiency (W 35°C / W 55°C)	ηs %	256 / 171	256 / 171	256 / 171	256 / 171	232 / 160	212 / 160	206 / 163	194 / 158
Heating warm climate. Energy class (W 35°C / W 55°C) (1)	A+++ to D	A+++ / A+++	A+++ / A+++	A+++ / A+++	A+++ / A+++	A+++ / A+++	A+++ / A+++	A+++ / A+++	A+++ / A+++
Heating cold climate. Seasonal energy efficiency (W 35°C / W 55°C)	SCOP	4,31 / 3,26	4,31 / 3,26	4,31 / 3,26	4,31 / 3,26	3,83 / 3,20	3,07 / 2,57	3,16 / 2,71	3,20 / 2,71
Heating cold climate. Seasonal energy efficiency (W 35°C / W 55°C)	ηs %	169 / 127	169 / 127	169 / 127	169 / 127	150 / 125	120 / 100	123 / 105	125 / 105
Heating cold climate. Energy class (W 35°C / W 55°C) (1)	A+++ to D	A++ / A++	A++ / A++	A++ / A++	A++ / A++	A++ / A++	A / A+	A / A+	A / A+
Outdoor sound power (Heat) (2)	dB(A)	52	53	52	53	57	56	59	61
Outdoor dimension (Height)	mm	1.520	1.520	1.520	1.520	1.520	1.645	1.645	1.645
Outdoor dimension (Width)	mm	1.200	1.200	1.200	1.200	1.200	1.500	1.500	1.500
Outdoor dimension (Depth)	mm	430	430	430	430	430	460	460	460
Outdoor net weight	kg	161	161	161	161	165	240	240	240
A class pump (Number of speeds)		Variable speed	Variable speed	Variable speed	Variable speed	Variable speed	Variable speed	Variable speed	Variable speed
A class pump (Input power Min)	W	30	30	30	30	30	230	230	230
A class pump (Input power Max)	W	175	175	175	175	175			
Heating water flow (ΔT=5 K, 35°C)	L/min	25,8	34,4	25,8	34,4	45,9	57,3	71,6	86,0
Operation range - Outdoor ambient (Heat)	°C	-28 ~ +35	-28 ~ +35	-28 ~ +35	-28 ~ +35	-28 ~ +35	-25 ~ +35	-25 ~ +35	-25 ~ +35
Operation range - Outdoor ambient (Cool)	°C	+10 ~ +43	+10 ~ +43	+10 ~ +43	+10 ~ +43	+10 ~ +43	+10 ~ +43	+10 ~ +43	+10 ~ +43
Water outlet (Heat)	°C	25 ~ 75	25 ~ 75	25 ~ 75	25 ~ 75	25 ~ 75	20 ~ 75 (4)	20 ~ 75 (4)	20 ~ 75 (4)
Water outlet (Cool)	°C	5 ~ 20	5 ~ 20	5 ~ 20	5 ~ 20	5 ~ 20	5 ~ 20	5 ~ 20	5 ~ 20
Indoor dimension (Height)	mm	450	450	450	450	450	450	450	450
Indoor dimension (Width)	mm	450	450	450	450	450	450	450	450
Indoor dimension (Depth)	mm	117	117	117	117	117	116	116	116
Indoor net weight	kg	7	7	7	7	7	7	7	7

Dimensions

Aquarea T-CAP Hydraulic M Series outdoor units from 9 to 16 kW.

