



stylish

where innovation meets creativity



# Stylish wall mounted unit

Designed for comfort

With more than 95 years of experience in air conditioning and climate control solutions, Daikin combines the best of design and technology to help you achieve your perfect climate. To meet market demands, Daikin is proud to present a new edition to the wall mounted segment: Stylish.

## Why choose Stylish?

Stylish brings together excellent design and technology to deliver a total climate solution for any interior. Measuring only 189 mm, Stylish is the thinnest unit on the market in the design segment for wall mounted units and uses innovative features to achieve the best in comfort, energy efficiency, reliability and control.

## Award-winning design

Inspired by its predecessors, Daikin Emura and Ururu Sarara, Stylish earned the Good Design Award for its innovative look and functional capabilities. This award also recognises Stylish for its ability to achieve new standards of comfort and energy efficiency in the HVAC-R industry.



reddot award 2018  
winner



**GOOD DESIGN  
AWARD 2017**



stylish

# Technology meets design for a premium climate solution



Side view



Top view

Most consumers today are looking for an air conditioning system that combines the best of performance and design. With Stylish, Daikin balances function and aesthetic to create an innovative product that suits any interior.

## Stylish design benefits

- › Users can choose from **four distinct colours** (white, silver, black and blackwood)
- › **Curved corners** create an unobtrusive and space-saving design
- › **Thin dimensions** make it the most compact design unit on the market
- › Simple panel enables variation in texture and colour to easily blend into any room

## Intelligent and efficient design

- › Smart sensors optimise performance
- › Coanda effect optimises room temperature distribution
- › Improved fan offers high-efficiency with low sound levels
- › Advanced technology achieves more comfort and energy efficiency



Bottom view

WHITE



SILVER



BLACK



BLACKWOOD

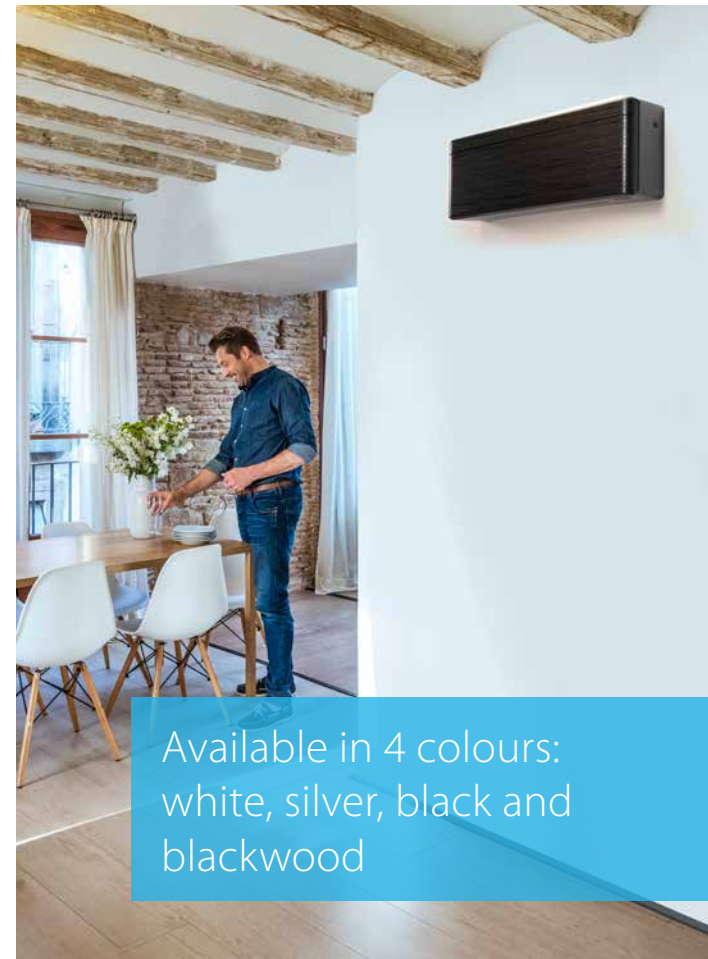

Available in 4 colours:  
white, silver, black and  
blackwood

# A closer look inside Stylish, and the technologies at work

## The Coanda effect

Already present in the Ururu Sarara, the **Coanda effect** optimises the airflow for a comfortable climate. By using specially designed flaps, a more focused airflow allows a better temperature distribution throughout the whole room.

### How it works

Stylish determines the airflow pattern based on whether the room needs heating or cooling. When Stylish is in heating mode, two flaps will direct air downward (vertical airflow), while in cooling mode the flaps will move air upward (ceiling airflow).

By creating two different airflow patterns, Stylish prevents draughts and establishes a more stable and comfortable room temperature for occupants.

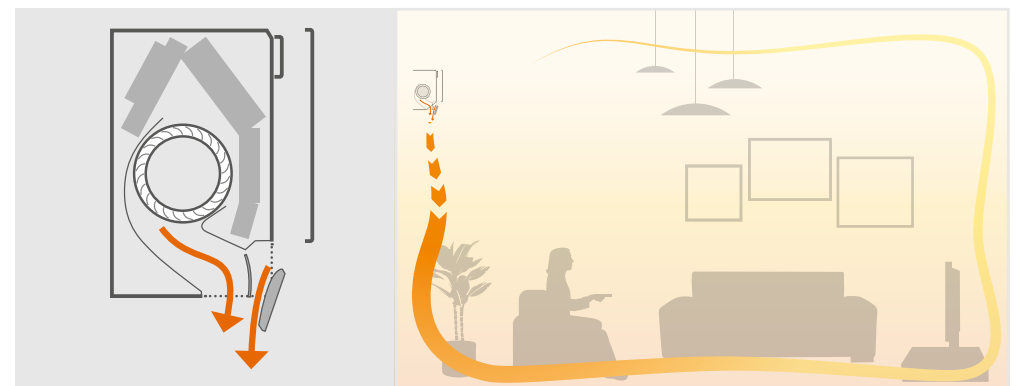
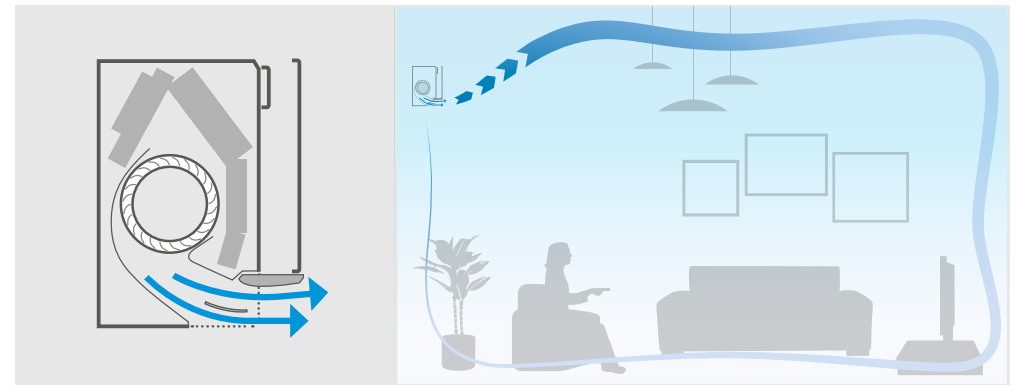

The Coanda effect creates two different airflow patterns depending on whether Stylish is in cooling or heating mode. On the top is the Coanda effect in cooling mode (ceiling airflow), while the bottom images demonstrate the Coanda effect in heating mode (vertical airflow).

## Controlled humidity

Comfort is not only related to indoor air quality or temperature; it's also about humidity. Stylish uses a few different settings to automatically adjust its fan and compressors to create the right **balance between temperature and humidity** for a room.

## Fresh, pure air

The **different type of filters** remove odours, allergens and dust.

		Odours	Allergens	Dust
Flash streamer	Using electrons to trigger chemical reactions with air borne particles, the Flash Streamer breaks down allergens such as pollen and fungal allergens and removes bothersome odours providing a better, cleaner air	•	•	
Titanium apatite deodorising filter	Decomposes bothersome odours of for example tobacco and pets	•		
Silver allergen removal and air purifying filter	Captures allergens such as pollen to ensure a steady supply of clean air		•	
Air filter	Removes airborne dust particles to ensure a steady supply of clean air			•

## Stable room temperatures

Stylish uses a **intelligent thermal sensor** to detect the surface temperature of a room to create a more comfortable climate.

After determining the current room temperature, the intelligent thermal sensor distributes air evenly throughout the room before switching to an airflow pattern that directs warm or cool air to areas that need it.

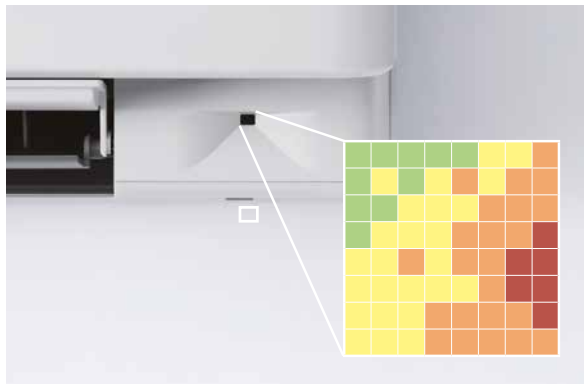

The intelligent thermal sensor measures the surface temperature of a room by dividing it into a grid with 64 different squares.

## Quiet operation

Stylish uses a **newly designed fan** to optimise airflow for higher energy efficiency at low sound levels.

To achieve higher energy efficiency, Daikin designed a new fan that runs efficiently within Stylish's compact dimensions. Together, the fan and heat exchanger attain top energy performance but operate at a sound level that is practically inaudible to occupants.

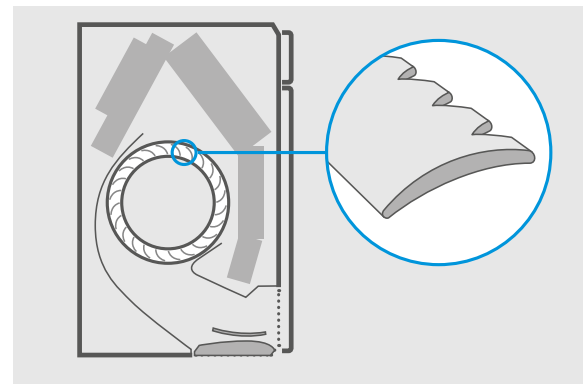

Sound dispersion and noise reduction are the results of new fan design.



To create an innovative wall mounted unit, Daikin uses in-house technologies to ensure the best performance and reliable operation.

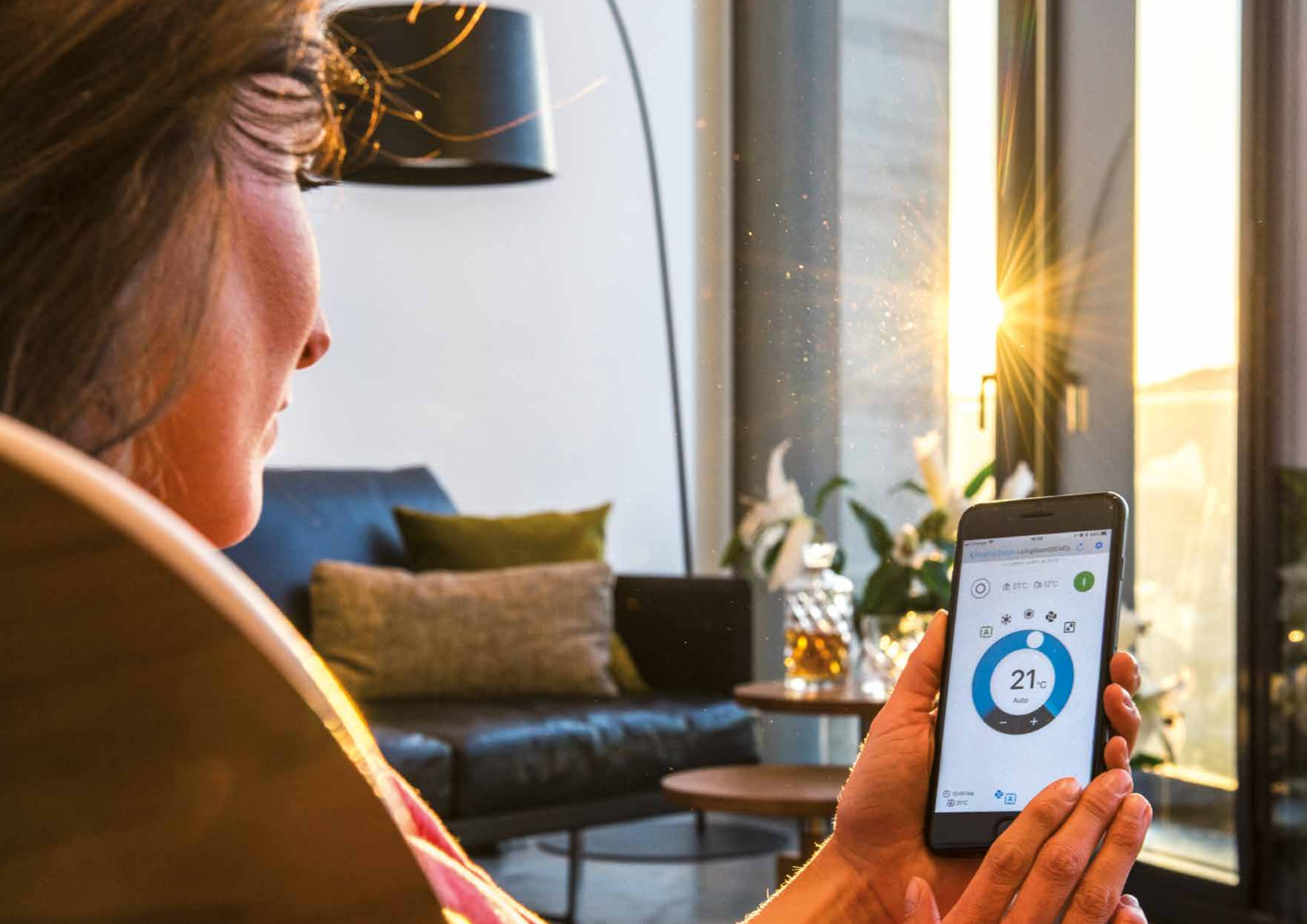



# Smart climate control

wherever you go

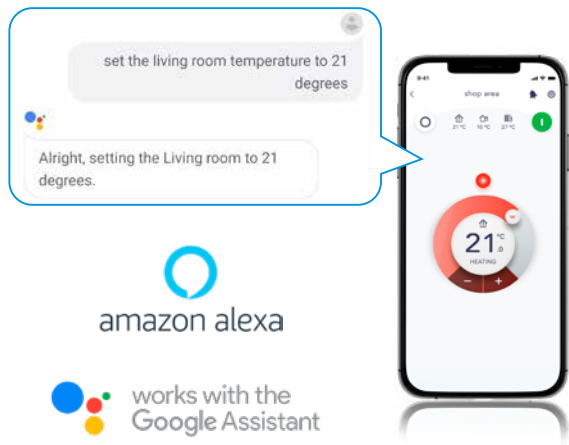

## ONEcta app

You can also manage Stylish using your smartphone. Simply connect to WLAN and download the Onecta app to begin creating your perfect climate.

### Your benefits

- › Access several features to control your climate
- › Manage the temperature, operating mode, air purification and fans with interactive thermostat
- › Create different schedules and operation modes
- › Monitor energy consumption

## Infrared remote control

The Infrared remote control allows you to manage Stylish and optimise its performance.

### Your benefits

- › Intuitive interface makes controlling your climate easy
- › Keep track of energy consumption with visual display graphs
- › Contemporary and lightweight design matches Stylish features

**NEW** Control your system and enjoy maximum comfort, just by using your voice. Via Amazon Alexa or Google Assistant you can control main functions such as temperature set point, operation mode, fan speed, and much more!

Available  
in 4 colours:  
white, silver, black  
and blackwood

# Functional and stylish

for any space



White: FTXA-AW

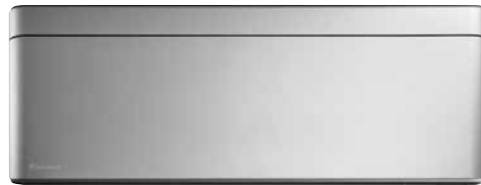

Silver: FTXA-BS

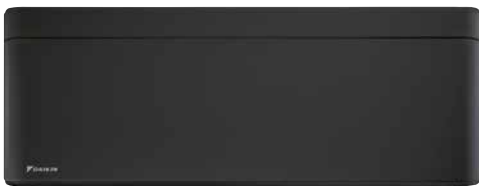

Black: FTXA-BB



Blackwood: FTXA-BT

## Stylish advantages

- > A compact and functional design suitable for all interiors
- > Earns A+++ for heating and cooling
- > Achieves higher energy efficiency and lower environmental impact with refrigerant R-32
- > New technologies create ideal room temperatures
- > Enhanced fan ensures the unit is inaudible
- > Easily controlled with Onecta app
- > Flash Streamer technology provides fresh, healthy air



BLUEEVOLUTION

## Less is more!

A Daikin multi split system offers you unexpected possibilities in creating a comfortable and cosy home. This is your solution to reduce limitations like environmental impact and financial aspects. You can choose between 2 options.

**Multi outdoor unit**  
for cooling and heating  
(up to 5 indoor units)

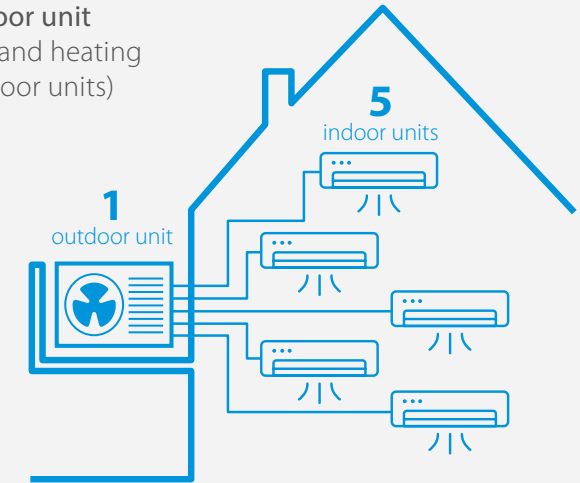

**Pair application**  
for cooling and heating

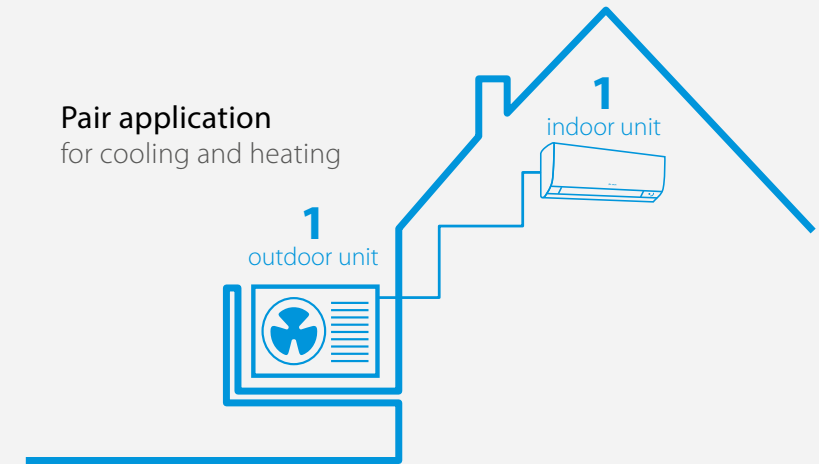

Pair outdoor unit



**NEW**  
Design multi outdoor unit for the full range

Indoor Units	White (RAL 9002)		CTXA15AW	FTXA20AW	FTXA25AW	FTXA35AW	UK.FTXA42AW	FTXA50AW
	Black (RAL 9005)		CTXA15BB	FTXA20BB	FTXA25BB	FTXA35BB	UK.FTXA42BB	FTXA50BB
	Silver (RAL 9006)		CTXA15BS	FTXA20BS	FTXA25BS	FTXA35BS	UK.FTXA42BS	FTXA50BS
	Blackwood (RAL N/A)		CTXA15BT	FTXA20BT	FTXA25BT	FTXA35BT	UK.FTXA42BT	FTXA50BT
Capacity	UK Total Cooling	kW	Multi Combination Only	1.95	2.44	3.32	4.11	4.89
	UK Sensible Cooling	kW		1.95	1.96	2.43	3.01	3.56
	Nominal Cooling	kW		2.0	2.5	3.4	4.2	5.0
	Nominal Heating	kW		2.5	2.8	4.0	5.4	5.8
Seasonal Efficiency (EN14825) COOLING	Energy Label			A+++	A+++	A+++	A++	A++
	Pdesign	kW		2.0	2.5	3.4	4.2	5.0
	SEER			8.75	8.74	8.73	7.50	7.33
	Annual Energy Consumption	kWh		80	101	137	196	239
Seasonal Efficiency (EN14825) HEATING	Energy Label			A+++	A+++	A+++	A++	A++
	Pdesign	kW		2.40	2.45	2.50	3.80	4.00
	SCOP			5.15	5.15	5.15	4.6	4.6
	Annual Energy Consumption	kWh		653	666	680	1150	1217
Air Flow Rate (Cooling)	High / Med / Low / Silent	m³/sec	0.183 / 0.136 / 0.102 / 0.077	0.183 / 0.136 / 0.102 / 0.077	0.192 / 0.143 / 0.102 / 0.077	0.198 / 0.143 / 0.102 / 0.077	0.218 / 0.167 / 0.120 / 0.077	0.225 / 0.173 / 0.127 / 0.087
Dimensions	Height / Width / Depth	mm	295 x 798 x 189	295 x 798 x 189	295 x 798 x 189	295 x 798 x 189	295 x 798 x 189	295 x 798 x 189
Weight		kg	12	12	12	12	12	
Sound Pressure (Cooling)	High / Med / Low / Silent	dB(A)	39 / 32 / 25 / 21	39 / 32 / 25 / 19	40 / 33 / 25 / 19	41 / 33 / 25 / 19	45 / 37 / 29 / 21	46 / 39 / 31 / 24
Sound Power (Cooling)		dB(A)	57	57	57	60	60	60

Outdoor Units			RXA20A9	RXA25A9	RXA35A9	RXA42B9	RXA50B
Dimensions	Height x Width x Depth	mm	550 x 840 x 350	550 x 840 x 350	550 x 840 x 350	734 x 870 x 373	734 x 870 x 373
Weight		kg	32	32	32	50	50
Electrical Details	Power Supply		1ph	1ph	1ph	1ph	1ph
	Maximum Input Current (MCA)	A	9.9	11	11	12.8	12.8
	Max Fuse Size	A	10	16	16	16	16
Interconnection Wiring	Core / Cable Size		3+E / 1.5	3+E / 1.5	3+E / 1.5	3+E / 1.5	3+E / 1.5
Piping Connections	Liquid / Gas	inches (mm)	1/4 (6.4) / 3/8 (9.5)	1/4 (6.4) / 3/8 (9.5)	1/4 (6.4) / 3/8 (9.5)	1/4 (6.4) / 3/8 (9.5)	1/4 (6.4) / 1/2 (12.7)
Pipework	Maximum Length	m	20	20	20	30	30
	Maximum Vertical Rise	m	15	15	15	20	20
	Precharged to	m	10	10	10	10	10
	Additional charge	g/m	20	20	20	20	20
Holding charge	kg	0.76	0.76	0.76	1.1	1.1	
Sound Pressure (Cooling)	Nominal	dB(A)	46	46	49	48	48
Sound Power (Cooling)		dB(A)	59	59	61	62	62
Operating Range (Cooling)	Min / Max	°CDB	-10 / 46	-10 / 46	-10 / 46	-10 / 46	-10 / 46
Operating Range (Heating)	Min / Max	°CWB	-15 / 18	-15 / 18	-15 / 18	-15 / 18	-15 / 18
Air Flow Rate (Cooling)	Nominal	m³/sec	0.567	0.567	0.600	0.757	0.777
Meets ETL criteria			•	•	•	•	•

## Accessories:

Accessory Ref	Description
EKRS21	Wire harness for new S21 port for all marked (*) options
BRC073*	Wired remote control - connection cable required
BRCW901A03	3m extension cord required for wired remote controller BRC073
BRCW901A08	8m extension cord required for wired remote controller BRC073
K.CGM	Condensing unit guard (1150 x 1150 x 650)
K.CGS	Condensing unit guard (750 x 1050 x 460)
K.CWB90-2	Condensing unit bracket - for up to size 71, max weight 90kg of ODU
K.DT1	Condensate drip tray for use with K.CWB90-2
KLIC-DDV3*	KNX interface for Split type systems
KRP413A15*	Adaptor PCB for remote on/off control - constant/pulse contact
KRP928A25*	Adaptor PCB for interface to Daikin centralised control systems
RTD-RA*	Adaptor PCB for Modbus connection and/or extended system functions

## Notes & Features:

- › All fan coils are supplied with infrared remote controller ARC466A58
- › New fan with Coanda effect for optimum air distribution and indoor comfort
- › New grid eye sensor redirects air away from the occupants in the room
- › Flash Streamer technology helps improve indoor air quality
- › Can be connected with R410A Mini VRV using BPMK boxes except for CXTA
- › RXA20-35A9 can reduce the sound power by a further 6 dB(A)
- › UK.FTXA42AW/BS/B/T comes with gas reducer adaptor ASYCP1R from 12.7 (1/2) mm to 9.52 (3/8)

Contains fluorinated greenhouse gases | See separate drawing for operation range | See separate drawing for electrical data | Nominal cooling capacities are based on: indoor temperature: 27°CDB, 19°CWB, outdoor temperature: 35°CDB, equivalent refrigerant piping: 5m, level difference: 0m. | Nominal heating capacities are based on: indoor temperature: 20°CDB, outdoor temperature: 7°CDB, 6°CWB, equivalent refrigerant piping: 5m, level difference: 0m.

EER/COP according to Eurovent 2012, for outside EU only. MFA is used to select the circuit breaker and the ground fault circuit interrupter (earth leakage circuit breaker). **Contains fluorinated greenhouse gases.** Actual refrigerant charge depends on the final unit construction, details can be found on the unit labels.

Connectable Indoor Units		Multi (cooling and heating)								
		2MXM40A9	2MXM50A9	2MXM68A9	3MXM40A9	3MXM52A9	3MXM68A9	4MXM68A9	4MXM80A9	5MXM90A9
Wall mounted	CTXA-AW/BS/BB/BT	15	•	•	•	•	•	•	•	•
		20	•	•	•	•	•	•	•	•
		25	•	•	•	•	•	•	•	•
	FTXA-AW/BS/BB/BT	35	•	•	•	•	•	•	•	•
		42	•	•	•	•	•	•	•	•
		50	•	•	•	•	•	•	•	•



Have a look at the Stylish video



Discover the Stylish website



Visualise the Stylish unit in your own house with the 3D app



Contact us for more information



[www.daikin.co.uk](http://www.daikin.co.uk)

**Daikin Airconditioning UK Limited** The Heights Brooklands Weybridge Surrey KT13 0NY Tel 01932 879000 [daikin.co.uk](http://daikin.co.uk)

ECPEN23-008 08/2023



FSC

The present leaflet is drawn up by way of information only and does not constitute an offer binding upon Daikin UK. Daikin UK has compiled the content of this leaflet to the best of its knowledge. No express or implied warranty is given for the completeness, accuracy, reliability or fitness for particular purpose of its content and the products and services presented therein. Specifications are subject to change without prior notice. Daikin UK explicitly rejects any liability for any direct or indirect damage, in the broadest sense, arising from or related to the use and/or interpretation of this leaflet. All content is copyrighted by Daikin UK.

Printed on non-chlorinated paper.