

Air Conditioning
Technical Data

AZAS-MY1



TABLE OF CONTENTS

AZAS-MY1

1	Features	2
2	Specifications	3
	Capacity and Power input	3
	Capacity and Power input	3
	Capacity and Power input	3
	Technical Specifications	4
	Electrical Specifications	5
3	Electrical data	6
4	Options	7
5	Combination table	8
6	Capacity tables	9
	Cooling/Heating Capacity Tables	9
	Capacity Correction Factor	11
7	Dimensional drawings	12
8	Centre of gravity	13
9	Piping diagrams	14
10	Wiring diagrams	15
	Wiring Diagrams - Three Phase	15
11	Sound data	16
	Sound Power Spectrum	16
	Sound Pressure Spectrum - Cooling	18
	Sound Pressure Spectrum - Heating	20
	Sound Pressure Spectrum Quiet Mode	22
12	Installation	24
	Installation Method	24
13	Operation range	26

1 Features

Ideal solution for busy environments and small shops

- High efficiency: - Energy labels up to A+ (cooling) / A (heating) - compressor offers substantial efficiency improvements
- Choosing for an R-32 product, reduces the environmental impact with 68% compared to R-410A, leads directly to lower energy consumption thanks to its high energy efficiency and has a lower refrigerant charge
- Very compact and easy to install
- Replace existing systems with R-32 technology without needing to replace the piping
- Guarantees operation in heating mode down to -15°C and in cooling mode down to -5°C
- Refrigerant cooled PCB guarantees reliable cooling, as it is not influenced by ambient temperature.
- Piping length up to 30m
- Exclusively offered for pair applications



Inverter



Auto cooling-
heating
changeover

2 Specifications

2-1 Capacity and Power input			FCAG100A/AZAS100M7Y1B	FCAG125A/AZAS125M7Y1B	FCAG140A/AZAS140M7Y1B	
Indoor unit			FCAG100AVEB	FCAG125AVEB	FCAG140AVEB	
Outdoor unit			AZAS100M7Y1B	AZAS125M7Y1B	AZAS140M7Y1B	
Cooling capacity	Nom.	kW	9.50 (1)	12.1 (1)	13.4 (1)	
Heating capacity	Nom.	kW	10.8 (2)	13.5 (2)	15.5 (2)	
Seasonal efficiency (according to EN14825)	Cooling	Energy efficiency class	A+			
		Pdesign	kW	9.50	12.1	13.0
		SEER		5.67	5.40	6.00
		Annual energy consumption	kWh	586	1,345	1,300
	Heating (Average climate)	Energy efficiency class	A			
		Pdesign	kW	6.00		7.80
		SCOP/A		3.85	3.80	4.31
		Annual energy consumption	kWh	2,182	2,211	2,534

Notes

- (1) Nominal cooling capacities are based on: indoor temperature: 27°CDB, 19°CWB, outdoor temperature: 35°CDB, equivalent refrigerant piping: 5m, level difference: 0m.
 (2) Nominal heating capacities are based on: indoor temperature: 20°CDB, outdoor temperature: 7°CDB, 6°CWB, equivalent refrigerant piping: 5m, level difference: 0m.

2-2 Capacity and Power input			FBA100A/AZAS100M7Y1B	FBA125A/AZAS125M7Y1B	FBA140A/AZAS140M7Y1B	
Indoor unit			FBA100A2VEB	FBA125A2VEB	FBA140A2VEB	
Outdoor unit			AZAS100M7Y1B	AZAS125M7Y1B	AZAS140M7Y1B	
Cooling capacity	Nom.	kW	9.50 (1)	12.1 (1)	13.4 (1)	
Heating capacity	Nom.	kW	10.8 (2)	13.5 (2)	15.5 (2)	
Seasonal efficiency (according to EN14825)	Cooling	Energy efficiency class	A			
		Pdesign	kW	9.50	12.1	13.0
		SEER		5.25	4.85	5.50
		Annual energy consumption	kWh	633	1,497	1,418
	Heating (Average climate)	Energy efficiency class	A			
		Pdesign	kW	6.00		7.80
		SCOP/A		3.81	3.55	3.85
		Annual energy consumption	kWh	2,205	2,366	2,836

Notes

- (1) Nominal cooling capacities are based on: indoor temperature: 27°CDB, 19°CWB, outdoor temperature: 35°CDB, equivalent refrigerant piping: 5m, level difference: 0m.
 (2) Nominal heating capacities are based on: indoor temperature: 20°CDB, outdoor temperature: 7°CDB, 6°CWB, equivalent refrigerant piping: 5m, level difference: 0m.

2-3 Capacity and Power input			FAA100A/AZAS100M7Y1B	
Indoor unit			FAA100AUVEB	
Outdoor unit			AZAS100M7Y1B	
Cooling capacity	Nom.	kW	9.50 (1)	
Heating capacity	Nom.	kW	10.8 (2)	
Seasonal efficiency (according to EN14825)	Cooling	Energy efficiency class	A	
		Pdesign	kW	9.50
		SEER		5.25
		Annual energy consumption	kWh	633
	Heating (Average climate)	Energy efficiency class	A	
		Pdesign	kW	6.00
		SCOP/A		3.81
		Annual energy consumption	kWh	2,205

2 Specifications

Notes

(1) Nominal cooling capacities are based on: indoor temperature: 27°CDB, 19°CWB, outdoor temperature: 35°CDB, equivalent refrigerant piping: 5m, level difference: 0m.

(2) Nominal heating capacities are based on: indoor temperature: 20°CDB, outdoor temperature: 7°CDB, 6°CWB, equivalent refrigerant piping: 5m, level difference: 0m.

2

2-4 Technical Specifications					AZAS100M7Y1B	AZAS125M7Y1B	AZAS140M7Y1B
Capacity control	Method				Inverter controlled		
Casing	Colour				Ivory white		
	Material				Painted galvanized steel plate		
Dimensions	Unit	Height	mm		990		
		Width	mm		940		
		Depth	mm		320		
	Packed unit	Height	mm		1,170		
		Width	mm		1,015		
		Depth	mm		422		
Weight	Unit		kg	70		77	
	Packed unit		kg	78		85	
Packing	Weight		kg	9			
Heat exchanger	Fin	Type			WF fin		
		Treatment			Anti-corrosion treatment (PE)		
Compressor	Quantity				1		
	Type				Hermetically sealed swing compressor		
	Starting method				Inverter driven		
Fan	Type				Propeller		
	Discharge direction				Horizontal		
	Quantity				1		
	Air flow rate	Cooling	Nom.	m ³ /min	69	71	76
		Heating	Nom.	m ³ /min	82		
Fan motor	Quantity				1		
	Model				Brushless DC motor		
	Output			W	200		
	Drive				Direct drive		
	Speed	Cooling	Super low	rpm	-		
			Heating	Super low	rpm	-	
Sound power level	Cooling			dBA	70	71	73
	Heating			dBA	-		
Sound pressure level	Night quiet mode	Level 2		dBA	44		
	Cooling	Nom.		dBA	53	54	
	Heating	Nom.		dBA	57		
Operation range	Cooling	Ambient	Min.	°CDB	-5		
			Max.	°CDB	46		
	Heating	Ambient	Min.	°CWB	-15		
			Max.	°CWB	15.5		
Refrigerant	Type				R-32		
	Charge			kg	2.60		2.90
				TCO _{2eq}	1.76		1.96
	Control				Expansion valve (electronic type)		
	GWP				675		
	Circuits	Quantity			1		

2 Specifications

2-4 Technical Specifications				AZAS100M7Y1B	AZAS125M7Y1B	AZAS140M7Y1B	
Piping connections	Liquid	Quantity		1			
		Type		Flare connection			
		OD	mm	9,52			
	Gas	Quantity		1			
		Type		Flare connection			
		OD	mm	15.9			
	Drain	Quantity		5			
		Type		Hole			
		ID	mm	-			
		OD	mm	26			
	Piping length	OU - IU	Min.	m	5		
			Max.	m	30		
		System	Equivalent	m	50		
			Chargeless	m	30		
Additional refrigerant charge			kg/m	See installation manual			
Level difference	IU - OU	Max.	m	30.0			
	IU - IU	Max.	m	0.5			
Heat insulation			Both liquid and gas pipes				
Refrigerant oil	Type			FW68DA			
	Charged volume		l	0.90		1.35	
Defrost method			Reversed cycle				
Defrost control			Sensor for outdoor heat exchanger temperature				
Safety devices	Item	01	High pressure switch				
		02	Low pressure switch				
		03	Fan driver overload protector				
		04	Fuse				
		05	Compressor motor thermal protector				

Standard Accessories : Tie-wraps; Quantity : 2;

Standard Accessories : Installation manual; Quantity : 1;

Standard Accessories : Refrigerant label for F-gas regulation; Quantity : 1;

Standard Accessories : General safety precautions; Quantity : 1;

Standard Accessories : LOT10 Energy Label; Quantity : 1;

2-5 Electrical Specifications				AZAS100M7Y1B	AZAS125M7Y1B	AZAS140M7Y1B
Power supply	Name		Y1			
	Phase		3~			
	Frequency	Hz	50			
	Voltage	V	380-415			
Current - 50Hz	Maximum fuse amps (MFA)	A	16			
Current	Zmax	List	Complies to EN61000-3-11			
	Minimum Ssc value	kVa	Equipment complying with EN / IEC 61000-3-2 / (1) / See note 3			
Current - 60Hz	Maximum fuse amps (MFA)	A	-			
Wiring connections	For power supply		Remark	See installation manual outdoor unit		
	For connection with indoor		Remark	See installation manual outdoor unit		
Power supply intake			See installation manual outdoor unit			

Notes

(1) Ssc: Short-circuit power

(2) Nominal cooling capacities are based on: indoor temperature: 27°CDB, 19°CWB, outdoor temperature: 35°CDB, equivalent refrigerant piping: 5m, level difference: 0m.

European/international technical standard setting the limits for harmonic currents produced by equipment connected to public low-voltage system with input current larger than 16A and ≤ 75A per phase.

3 Electrical data

3 - 1 Electrical Data

3

AZAS71-140MV1

Indoor	Outdoor	Power supply	Voltage range		MCA	TOCA	MFA	Compressor		OFM		IFM	
								MSC	RLA	kW	FLA	kW	FLA
FCAG71AVEB	AZAS71M2V1B	50Hz ~ 220-240V	Minimum: 198 V Maximum: 264 V	17.4	—	20	—	15.4	0.094	0.9	0.054	0.4	
FBA71A2VEB	AZAS71M2V1B			17.5	—	20	—	15.4	0.094	0.9	0.070	0.5	
FAA71AUVEB	AZAS71M2V1B			17.4	—	20	—	15.4	0.094	0.9	0.048	0.4	
FCAG100AVEB	AZAS100M7V1B			21.5	—	25	—	19.0	0.200	1.0	0.117	0.7	
FBA100A2VEB	AZAS100M7V1B			21.8	—	25	—	19.0	0.200	1.0	0.127	1.0	
FAA100AUVEB	AZAS100M7V1B			21.2	—	25	—	19.0	0.200	1.0	0.064	0.4	
FCAG125AVEB	AZAS125M7V1B			27.8	—	32	—	24.7	0.200	1.0	0.168	1.0	
FBA125A2VEB	AZAS125M7V1B			28.3	—	32	—	24.7	0.200	1.0	0.187	1.5	
FCAG140AVEB	AZAS140M7V1B			27.0	—	32	—	24.0	0.200	1.0	0.168	1.0	
FBA140A2VEB	AZAS140M7V1B			27.6	—	32	—	24.0	0.200	1.0	0.187	1.5	
FCAG100AVEB	AZAS100M7Y1B	3N~ 50Hz 380-415V	Minimum: 342 V Maximum: 456 V	14.2	—	16	—	12.0	0.200	1.0	0.117	0.7	
FBA100A2VEB	AZAS100M7Y1B			14.6	—	16	—	12.0	0.200	1.0	0.127	1.0	
FAA100AUVEB	AZAS100M7Y1B			13.9	—	16	—	12.0	0.200	1.0	0.064	0.4	
FCAG125AVEB	AZAS125M7Y1B			14.6	—	16	—	12.0	0.200	1.0	0.168	1.0	
FBA125A2VEB	AZAS125M7Y1B			15.1	—	16	—	12.0	0.200	1.0	0.187	1.5	
FCAG140AVEB	AZAS140M7Y1B			14.6	—	16	—	12.0	0.200	1.0	0.168	1.0	
FBA140A2VEB	AZAS140M7Y1B			15.1	—	16	—	12.0	0.200	1.0	0.187	1.5	

3D110014A

AZAS-MV1

AZAS-MY1

RZAG-MV1

RZAG-MY1

RZASG-MV1

RZASG-MY1

Symbols

- MCA: Minimum Circuit Ampere [A]
- TOCA: Total overcurrent amps [A]
- MFA: Maximum Fuse Ampere [A]
- MSC: Maximum current of the starting compressor [A]
- RLA: Rated load amps [A]
- OFM: Outdoor fan motor
- IFM: Indoor fan motor
- FLA: Full Load Ampere [A]
- KW: Fan motor rated output [kW]

Notes

- The RLA is based on the following conditions.
 - Cooling
 - Indoor temperature 27.0°C DB / 19.0°C WB
 - Outdoor temperature 35.0°C DB
 - Heating
 - Indoor temperature 20.0°C DB
 - Outdoor temperature 7.0°C DB / 6.0°C WB
- TOCA is the total value of each overcurrent set.
- Voltage range
 - The units are suitable for use with electrical systems in which the voltage supplied to the unit terminals is not below or above the listed range limits.
- The maximum allowable voltage that is unbalanced between phases is 2%.
- MCA is the maximum input current.
 - The capacity of the MFA must be greater than that of the MCA.
 - Select the MFA according to the table.
- Select the wire size according to the MCA.
- MFA is used to select the circuit breaker and the ground fault circuit interruptor.
 - Earth leakage circuit breaker

3D110014A

4 Options

4 - 1 Options

AZAS-MV1

AZAS-MY1

RZAG-MV1

RZAG-MY1

Available options for RZAG models

RZASG-MV1

RZASG-MY1

Option		Option kit			
		RZAG71M7V1B RZAG71M7Y1B	RZAG100M7V1B RZAG100M7Y1B	RZAG125M7V1B RZAG125M7Y1B	RZAG140M7V1B RZAG140M7Y1B
Bottom plate heater		EKBPH140L7			
Refrigerant branch piping	Twin	KHRQ22M20TA			
	Triple	-	KHRQ127H		
	Double twin	-	KHRQ22M20TA (3x)		
Demand adaptor kit		SB.KRP58M52			

Available options for RZASG models

Option		Option kit			
		RZASG71M2V1B	RZASG100M7V1B RZASG100M7Y1B	RZASG125M7V1B RZASG125M7Y1B	RZASG140M7V1B RZASG140M7Y1B
Bottom plate heater		-			
Refrigerant branch piping	Twin	KHRQ22M20TA			
	Triple	-	KHRQ127H		
	Double twin	-	KHRQ22M20TA (3x)		
Demand adaptor kit		SB.KRP58M52			

Available options for AZAS models

Option		Option kit			
		AZAS71M2V1B	AZAS100M7V1B AZAS100M7Y1B	AZAS125M7V1B AZAS125M7Y1B	AZAS140M7V1B AZAS140M7Y1B
Demand adaptor kit		SB.KRP58M52			

3D108867

5 Combination table

5 - 1 Combination Table

5

AZAS-MV1
AZAS-MY1
RZAG-MV1
RZAG-MY1
RZASG-MV1
RZASG-MY1

Possible combinations

	71	100	125	140
2= Pair	35+35	50+50	60+60	71+71
2= Twin				
3= Triple		35+35+35 (*)	50+50+50 (*)	50+50+50 (*)
4= Double twin			35+35+35+35 (*)	35+35+35+35

(*) See note 1.

Sky Air		High Cassette			Thin cassette				2x2 cassette			Duct (medium ESP)			Concealed floor standing type			Ceiling-mounted - 4-way blow			Wall mounted type		Duct (high ESP)									
Model		FCAHG71GVEB	FCAHG100GVEB	FCAHG125GVEB	FCAHG140GVEB	FCAG35AVEB	FCAG60AVEB	FCAG90AVEB	FCAG120AVEB	FCAG140AVEB	FCAG125AVEB	FCAG140AVEB	FFA35A2VEB	FFA60A2VEB	FFA90A2VEB	FBA35A2VEB	FBA60A2VEB	FBA90A2VEB	FBA100A2VEB	FBA125A2VEB	FBA140A2VEB	FNA35A2VEB	FNA60A2VEB	FNA90A2VEB	FUA71AVEB	FUA100AVEB	FUA125AVEB	FAA71AUVB	FAA100AUVB	FDA125A5VEB		
RZAG71M7V1B	RZAG71M7Y1B	P				2						2			2							2				P				P		
RZAG100M7V1B	RZAG100M7Y1B		P			3	2					3	2		3	2						3	2			P				P		
RZAG125M7V1B	RZAG125M7Y1B			P		4	3	2				4	3	2	4	3	2					4	3	2							P	
RZAG140M7V1B	RZAG140M7Y1B	2			P	4	3	2				4	3	2	4	3	2					4	3	2			2				P	
RZASG71M2V1B						2						2			2							2				P					P	
RZASG100M7V1B	RZASG100M7Y1B					3	2					3	2		3	2						3	2				P				P	
RZASG125M7V1B	RZASG125M7Y1B					4	3	2				4	3	2	4	3	2					4	3	2							P	
RZASG140M7V1B	RZASG140M7Y1B					4	3	2				4	3	2	4	3	2					4	3	2			2				P	
AZAS71M2V1B																																P
AZAS100M7V1B	AZAS100M7Y1B																															P
AZAS125M7V1B	AZAS125M7Y1B																															P
AZAS140M7V1B	AZAS140M7Y1B																															P

Sky Air		Floor standing type			Slim duct		Ceiling-suspended							
Model		FVA71AMVEB	FVA100AMVEB	FVA125AMVEB	FVA140AMVEB	FDX103F3Y1B	FDX160F3Y1B	FDX160F3Y1B	FHA35AVEB	FHA60AVEB	FHA90AVEB	FHA100AVEB	FHA125AVEB	FHA140AVEB
RZAG71M7V1B	RZAG71M7Y1B	P				2			2					
RZAG100M7V1B	RZAG100M7Y1B		P			3	2		3	2				P
RZAG125M7V1B	RZAG125M7Y1B			P		4	3	2	4	3	2			P
RZAG140M7V1B	RZAG140M7Y1B	2			P	4	3	2	4	3	2			P
RZASG71M2V1B						2			2					P
RZASG100M7V1B	RZASG100M7Y1B		P			3	2		3	2				P
RZASG125M7V1B	RZASG125M7Y1B			P		4	3	2	4	3	2			P
RZASG140M7V1B	RZASG140M7Y1B	2			P	4	3	2	4	3	2			P
AZAS71M2V1B														
AZAS100M7V1B	AZAS100M7Y1B													
AZAS125M7V1B	AZAS125M7Y1B													
AZAS140M7V1B	AZAS140M7Y1B													

Notes

- Maximum capacity is limited based on outdoor unit capacity.
- When combining multiple indoor units, designate the unit whose remote controller is equipped with the most functions as the master unit.
- For the selection of the correct refnet kit, required to install a multi-combination, refer to the option list.

Twin : KHRQ(M)S8T
 Triple : KHRQ(M)S8H
 Double twin : KHRQ(M)S8T

3D108868A

6 Capacity tables

6 - 1 Cooling/Heating Capacity Tables

AZAS100MV1 AZAS100MY1

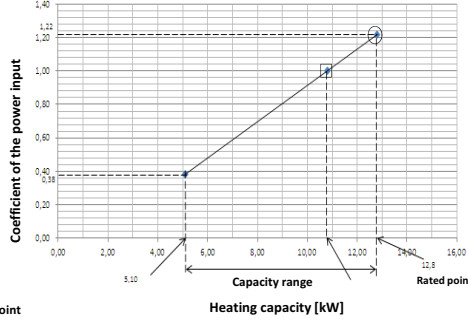
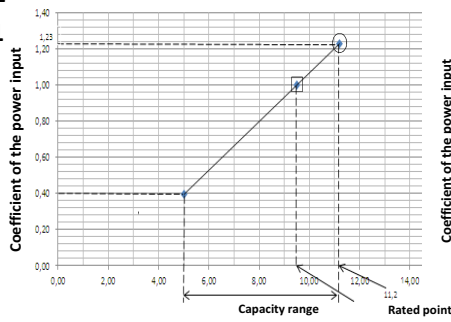

Symbols
 AFR: Air flow rate [m³/min]
 BF: Bypass factor
 EWB: Entering wet-bulb temperature (°C WB)
 EDB: Entering dry-bulb temperature (°C DB)
 TC: Maximum total cooling/heating capacity [kW]
 SHC: Sensible heat capacity [kW]
 CPI: Coefficient of the power input
 PI: Power input [kW]
 compressor + indoor and outdoor fan motors

Cooling capacity [kW]

Indoor		Outdoor Temperature (°C DB)											
		25			30			35			40		
°CWB	°CDB	kW	SHC	CPI	kW	SHC	CPI	kW	SHC	CPI	kW	SHC	CPI
16.0	22	11.2	7.61	1.01	10.8	7.44	1.11	10.5	7.29	1.22	10.1	7.09	1.32
18.0	25	11.8	7.59	1.01	11.4	7.49	1.12	11.0	7.27	1.23	10.5	7.09	1.33
19.0	27	12.0	7.57	1.02	11.6	7.44	1.12	11.2	7.26	1.23	10.8	7.04	1.33
19.5	27	12.1	7.59	1.02	11.7	7.37	1.13	11.4	7.34	1.23	10.9	7.04	1.34
22.0	30	12.8	7.52	1.02	12.4	7.36	1.13	11.9	7.16	1.24	11.5	7.03	1.35
24.0	32	13.3	7.42	1.03	12.9	7.27	1.14	12.4	7.06	1.25	12.0	6.91	1.36

Heating

Indoor		Outdoor temperature (°C WB)											
		-15.0		-10.0		-5.0		0.0		6.0		10.0	
°CDB	kW	CPI	kW	CPI	kW	CPI	kW	CPI	kW	CPI	kW	CPI	
16	8.58	0.93	9.45	0.99	10.1	1.02	10.4	1.05	12.8	1.12	13.8	1.18	
18	8.57	0.97	9.44	1.02	10.0	1.07	10.3	1.10	12.8	1.17	13.8	1.23	
20	8.56	1.01	9.43	1.07	10.0	1.11	10.3	1.14	12.8	1.22	13.8	1.28	
21	8.56	1.03	9.42	1.09	10.0	1.13	10.3	1.16	12.8	1.24	13.8	1.30	
22	8.55	1.04	9.42	1.10	10.0	1.14	10.3	1.18	12.8	1.26	13.8	1.33	
24	8.54	1.09	9.41	1.15	10.0	1.19	10.3	1.23	12.8	1.31	13.8	1.38	

- Notes**
- The ratings shown are net capacities which include a deduction for indoor fan motor heat.
 - = Maximum at standard conditions
□ = Rated capacity and rated coefficient of the power input
The maximum capacity is not guaranteed except at standard conditions.
 - SHC is based on indoor units EWB & EDB.
SHC for other dry-bulb temperatures = SHC + SHC*
SHC* = SHC correction for other dry-bulb temperatures
= 0.02 x AFR (m³/min) x (1-BF) x (DB* - EDB)
 - The capacities are based on the following conditions:
Outdoor air: 85% RH
However, the outdoor ambient condition of the rated capacity during heating operation is 7°C DB / 6°C WB.
Corresponding refrigerant piping length: 5.0 m
Level difference: 0m
 - CPI is a percentage value compared to the rated value which is 1.00.
 - The error rate for this value is less than 5% and depends on the indoor unit type.
 - The heating performance takes into account the drop that occurs during defrost operation.
 - The air flow rate and bypass factor are mentioned in the table.

9. The rated power input for each model is mentioned in the table below.

Pair

	FCAG100A	FAA100A	FBA100A
AFR	22.8	26.0	29.0
(BF)	(0.17)	(0.10)	(0.03)

Pair

	FCAG100A	FAA100A	FBA100A
Cooling	2.92	3.52	2.97
Heating	3.45	3.98	3.32

3D112149

AZAS125MV1 AZAS125MY1

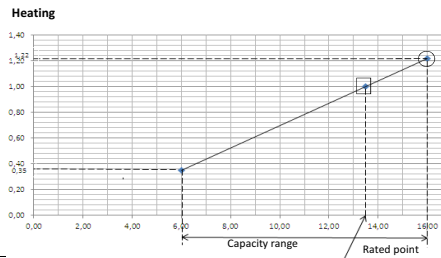
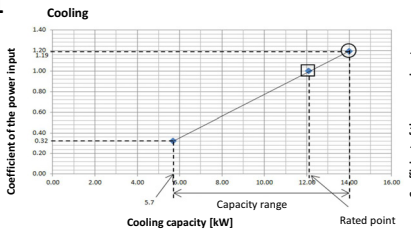

Symbols
 AFR: Air flow rate [m³/min]
 BF: Bypass factor
 EWB: Entering wet-bulb temperature (°C WB)
 EDB: Entering dry-bulb temperature (°C DB)
 TC: Maximum total cooling/heating capacity [kW]
 SHC: Sensible heat capacity [kW]
 CPI: Coefficient of the power input
 PI: Power input [kW]
 compressor + indoor and outdoor fan motors

Cooling

Indoor		Outdoor temperature (°C DB)											
		25			30			35			40		
°CWB	°CDB	kW	SHC	CPI	kW	SHC	CPI	kW	SHC	CPI	kW	SHC	CPI
16.0	22	14.10	9.54	0.97	13.60	9.30	1.08	13.30	9.12	1.18	12.60	8.78	1.28
18.0	25	14.70	9.50	0.97	14.20	9.32	1.08	13.70	9.09	1.19	13.20	8.83	1.30
19.0	27	15.00	9.52	0.99	14.50	9.34	1.09	14.00	9.06	1.19	13.50	8.87	1.29
19.5	27	15.20	9.52	0.99	14.70	9.26	1.09	14.20	9.08	1.19	13.60	8.81	1.30
22.0	30	16.00	9.39	0.99	15.50	9.14	1.09	14.90	8.95	1.20	14.40	8.74	1.31
24.0	32	16.70	9.31	1.00	16.10	9.09	1.11	15.50	8.83	1.21	15.00	8.63	1.32

Heating capacity [kW]

Heating

Indoor		Outdoor temperature (°C WB)											
		-15.0		-10.0		-5.0		0.0		6.0		10.0	
°CDB	kW	CPI	kW	CPI	kW	CPI	kW	CPI	kW	CPI	kW	CPI	
16	10.7	0.93	11.8	0.99	12.6	1.02	13.0	1.05	16.0	1.12	17.3	1.18	
18	10.7	0.97	11.8	1.02	12.5	1.07	12.9	1.10	16.0	1.17	17.3	1.23	
20	10.7	1.01	11.8	1.07	12.5	1.11	12.9	1.14	16.0	1.22	17.3	1.28	
21	10.7	1.03	11.8	1.09	12.5	1.13	12.9	1.16	16.0	1.24	17.3	1.31	
22	10.7	1.04	11.8	1.10	12.5	1.14	12.9	1.18	16.0	1.27	17.3	1.33	
24	10.7	1.09	11.8	1.15	12.5	1.19	12.9	1.23	16.0	1.31	17.3	1.38	

- Notes**
- The ratings shown are net capacities which include a deduction for indoor fan motor heat.
 - = Maximum at standard conditions
□ = Rated capacity and rated coefficient of the power input
The maximum capacity is not guaranteed except at standard conditions.
 - SHC is based on indoor units EWB & EDB.
SHC for other dry-bulb temperatures = SHC + SHC*
SHC* = SHC correction for other dry-bulb temperatures
= 0.02 x AFR (m³/min) x (1-BF) x (DB* - EDB)
 - The capacities are based on the following conditions:
Outdoor air: 85% RH
However, the outdoor ambient condition of the rated capacity during heating operation is 7°C DB / 6°C WB.
Corresponding refrigerant piping length: 5.0 m
Level difference: 0m
 - CPI is a percentage value compared to the rated value which is 1.00.
 - The error rate for this value is less than 5% and depends on the indoor unit type.
 - The heating performance takes into account the drop that occurs during defrost operation.
 - The air flow rate and bypass factor are mentioned in the table.

9. The rated power input for each model is mentioned in the table below.

Pair

	FCAG125A	AVA125A	FBA125A
AFR	26.0	28.0	34.0
(BF)	(0.21)	(0.14)	(0.06)

Pair

	FCAG125A	AVA125A	FBA125A
Cooling	5.28	5.11	5.26
Heating	3.44	3.60	3.23

3D112150

6 Capacity tables

6 - 1 Cooling/Heating Capacity Tables

AZAS140MV1
AZAS140MY1

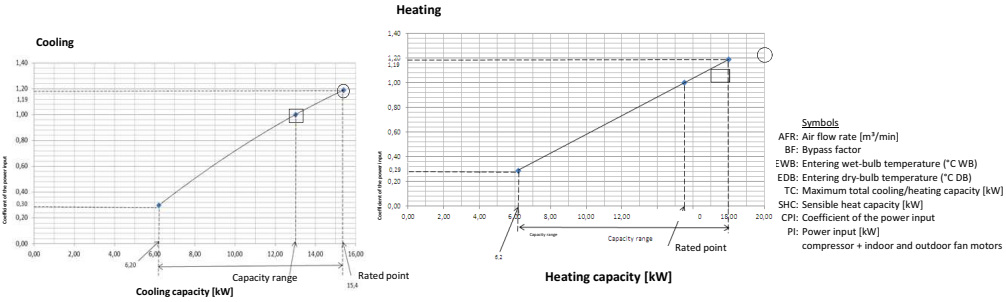

Cooling

Indoor		Outdoor temperature (°C DB)											
		25			30			35			40		
°CWB	°CDB	TC	SHC	CPI	TC	SHC	CPI	TC	SHC	CPI	TC	SHC	CPI
16.0	22	15.5	10.47	0.86	14.9	10.25	1.06	14.4	10.03	1.18	13.9	9.69	1.28
18.0	25	16.2	10.55	0.86	15.6	10.21	1.08	15.1	10.01	1.19	14.5	9.71	1.30
19.0	27	16.6	10.43	0.88	16.0	10.18	1.08	15.4	9.90	1.19	14.8	9.76	1.30
19.5	27	16.7	10.49	0.89	16.1	10.16	1.10	15.6	10.00	1.19	15.0	9.86	1.30
22.0	30	17.6	10.37	0.89	17.0	10.16	1.10	16.4	9.83	1.21	15.8	9.60	1.31
24.0	32	18.4	10.20	1.00	17.7	10.00	1.11	17.0	9.67	1.22	16.4	9.47	1.32

Heating

Indoor		Outdoor temperature (°C WB)											
		-15.0		-10.0		-5.0		0.0		6.0		10.0	
°CDB	°CWB	TC	CPI	TC	CPI	TC	CPI	TC	CPI	TC	CPI	TC	CPI
16	11.6	0.91	12.7	0.97	13.6	1.00	13.9	1.03	18.0	1.09	19.4	1.16	1.16
18	11.6	0.95	12.7	1.00	13.6	1.04	13.9	1.07	18.0	1.14	19.4	1.21	1.21
20	11.6	0.99	12.7	1.05	13.5	1.09	13.9	1.11	18.0	1.19	19.4	1.25	1.25
21	11.5	1.00	12.7	1.06	13.5	1.11	13.9	1.13	18.0	1.21	19.4	1.28	1.28
22	11.5	1.02	12.7	1.08	13.5	1.12	13.9	1.16	18.0	1.24	19.4	1.30	1.30
24	11.5	1.07	12.6	1.12	13.5	1.17	13.9	1.20	18.0	1.29	19.4	1.35	1.35

- Notes**
- The ratings shown are net capacities which include a deduction for indoor fan motor heat.
 - = Maximum at standard conditions
 - = Rated capacity and rated coefficient of the power input
The maximum capacity is not guaranteed except at standard conditions.
 - SHC is based on indoor units EWB & EDB.
SHC for other dry-bulb temperatures = SHC + SHC*
SHC = SHC correction for other dry-bulb temperatures
= 0.02 x AFR (m³/min) x (1-BF) x (DB* - EDB)
 - The capacities are based on the following conditions:
Outdoor air: 85% RH
However, the outdoor ambient condition of the rated capacity during heating operation is 7°C DB / 6°C WB.
Corresponding refrigerant piping length: 5.0 m
Level difference: 0m
 - CPI is a percentage value compared to the rated value which is 1.00.
 - The error rate for this value is less than 5% and depends on the indoor unit type.
 - The heating performance takes into account the drop that occurs during defrost operation.
 - The air flow rate and bypass factor are mentioned in the table.
 - The rated power input for each model is mentioned in the table below.

Pair

	FCAG140A	FBA140A
AFR	26.0	34.0
(BF)	(0.23)	(0.06)

Pair

	FCAG140A	FBA140A
Cooling	4,47	4,45
Heating	5,01	5,13

3D112151

6 Capacity tables

6 - 2 Capacity Correction Factor

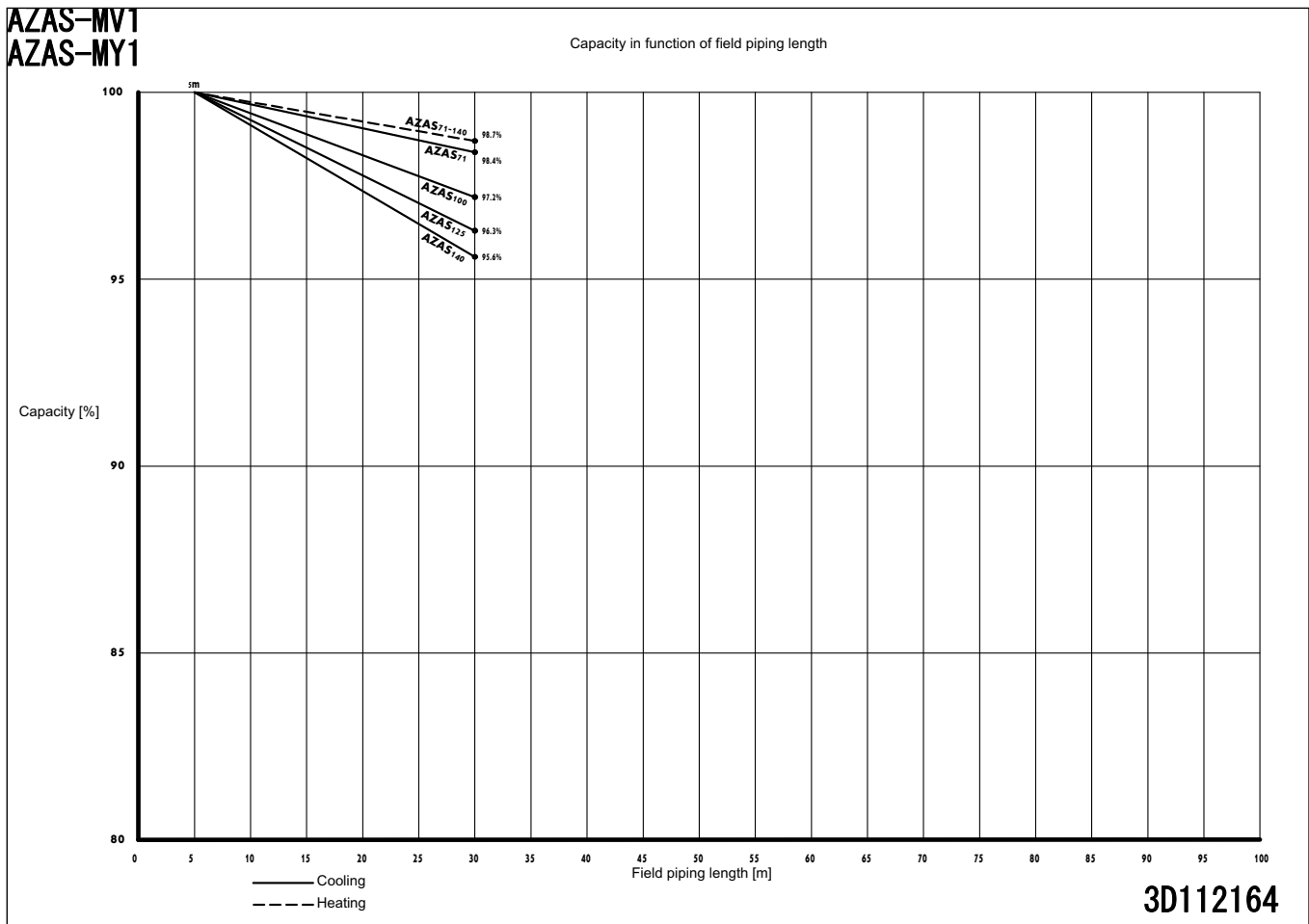

7 Dimensional drawings

7 - 1 Dimensional Drawings

7

AZAS100-140MV1

AZAS-MY1

RZAG71MV1

RZAG71MY1

RZASG100-140MV1

RZASG-MY1

4 holes for anchor bolts

M12

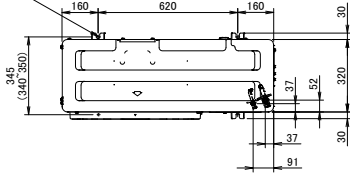

Model	AA	AB
RZAG71* / RZASG100-125* / AZAS100-125*	331	337
RZASG140* / AZAS140*	414	420

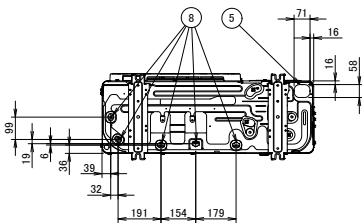
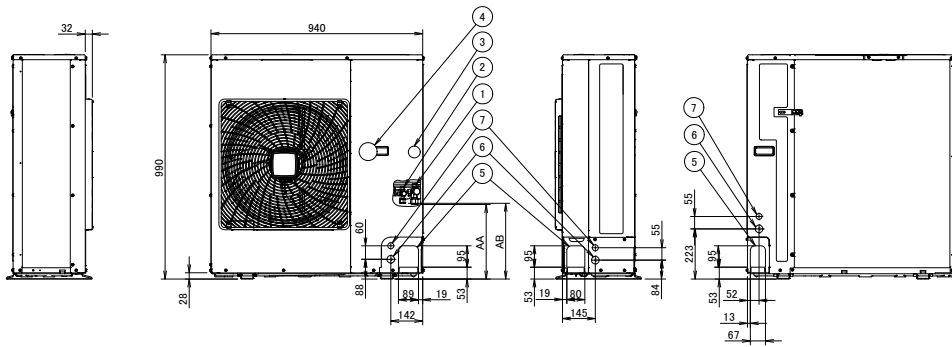

- ① Gas pipe connection $\text{Ø}15.9$ flare
- ② Liquid pipe connection $\text{Ø}9.5$ flare
- ③ Service port (in the unit)
- ④ Electronic connection and grounding terminal M5 (in the switch box)
- ⑤ Refrigerant piping intake
- ⑥ Power supply wiring intake (knockout hole $\text{Ø}34$)
- ⑦ Control wiring intake (knockout hole $\text{Ø}27$)
- ⑧ Drain outlet

3D110011

8 Centre of gravity

8 - 1 Centre of Gravity

AZAS100-140MV1

AZAS-MY1

RZAG71MV1

RZAG71MY1

RZASG100-140MV1

RZASG-MY1

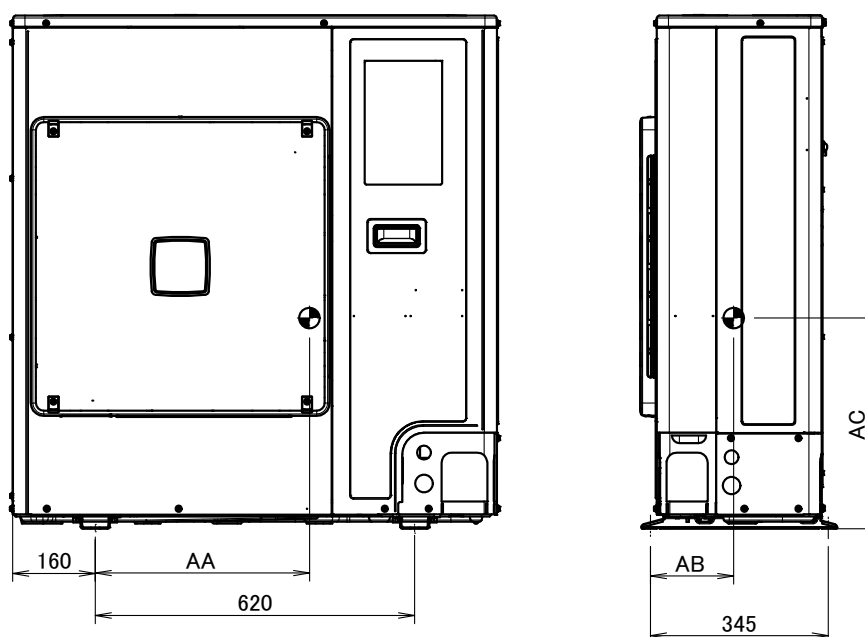

Model	AA	AB	AC
RZAG71M7V*	414	163	407
RZAG71M7Y*	432	137	407
RZASG100-125M7V* / AZAS100-125M7V*	425	181	422
RZASG100-125M7Y* / AZAS100-125M7Y*	414	156	417
RZASG140M7V* / AZAS140M7V*	414	161	423
RZASG140M7Y* / AZAS140M7Y*	416	151	418

4D110025

9 Piping diagrams

9 - 1 Piping Diagrams

9

AZAS-MV1
 AZAS-MY1
 RZAG-MV1
 RZAG-MY1
 RZASG-MV1
 RZASG-MY1

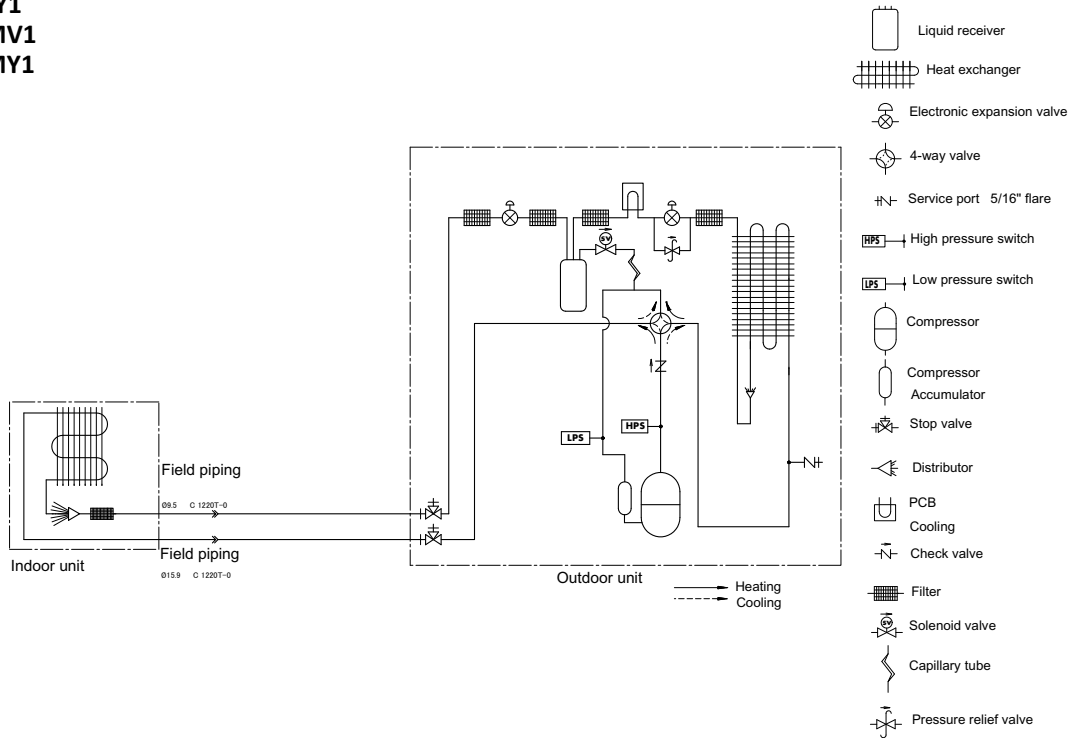

Notes

- The pipes between the branch and the indoor units should have the same size as the indoor connections.

3D108855A

10 Wiring diagrams

10 - 1 Wiring Diagrams - Three Phase

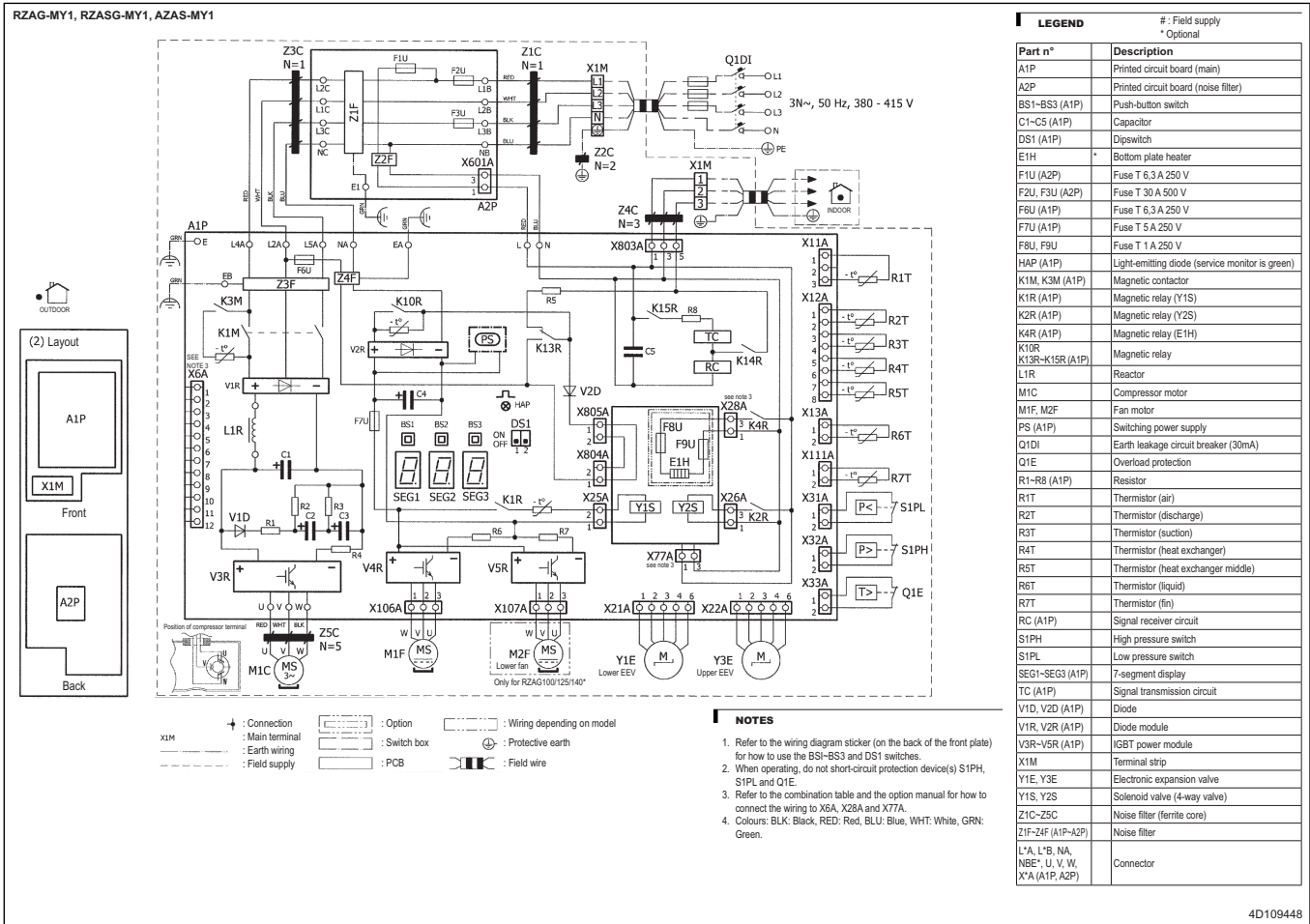

11 Sound data

11 - 1 Sound Power Spectrum

11

AZAS100MV1
 AZAS100MY1
 RZASG100MV1
 RZASG100MY1

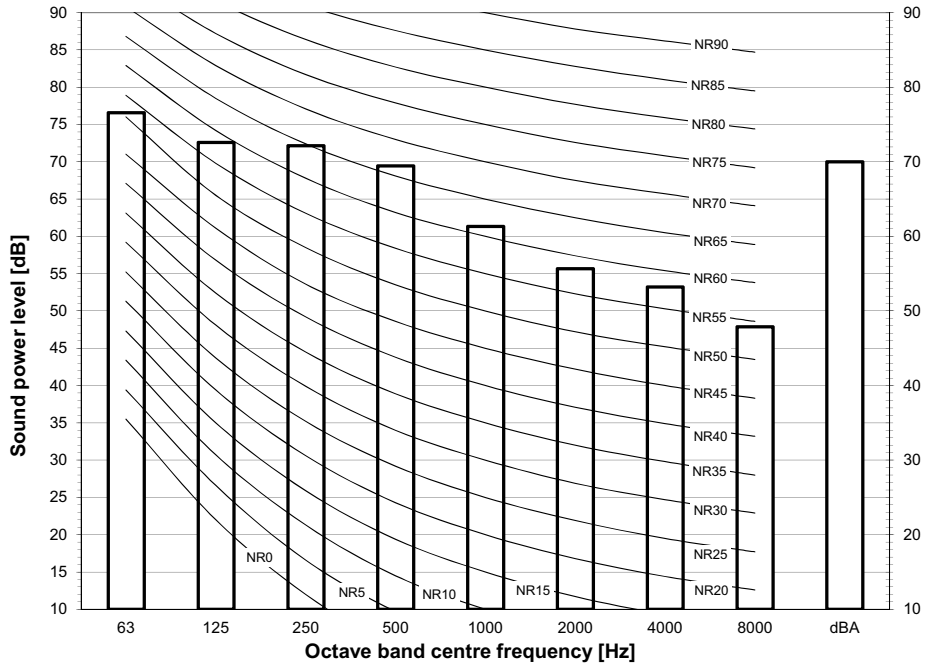

Notes
 - dBA = A-weighted sound power level (A scale according to IEC).
 - Reference acoustic intensity 0dB = 10E-6μW/m²
 - Measured according to ISO 3744

3D110038

AZAS125MV1
 AZAS125MY1
 RZASG125MV1
 RZASG125MY1

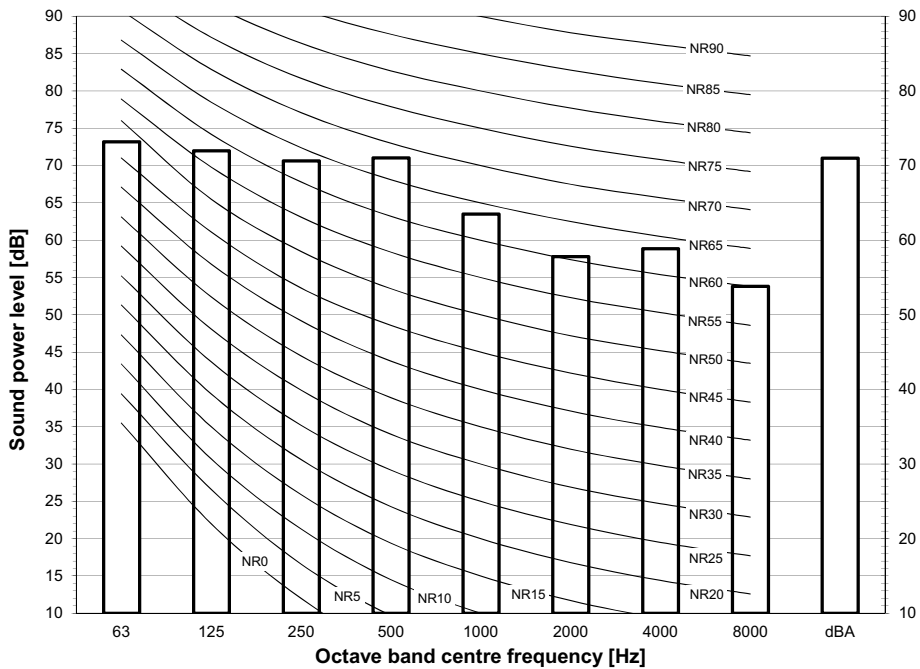

Notes
 - dBA = A-weighted sound power level (A scale according to IEC).
 - Reference acoustic intensity 0dB = 10E-6μW/m²
 - Measured according to ISO 3744

3D110039

11 Sound data

11 - 1 Sound Power Spectrum

AZAS140MV1
 AZAS140MY1
 RZASG140MV1
 RZASG140MY1

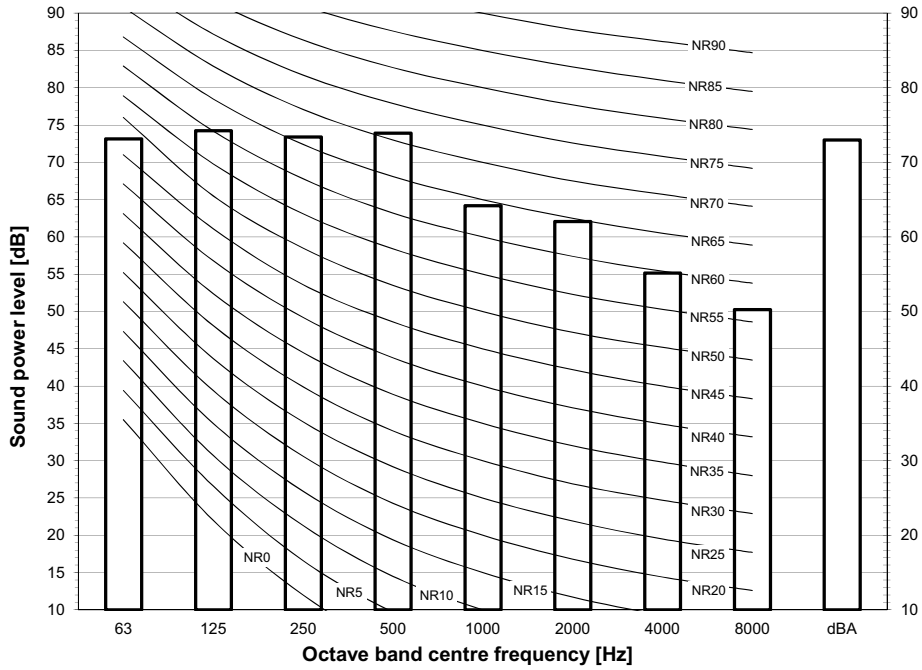

- Notes**
- dBA = A-weighted sound power level (A scale according to IEC).
 - Reference acoustic intensity 0dB = 10E-6μW/m²
 - Measured according to ISO 3744

3D110040

11 Sound data

11 - 2 Sound Pressure Spectrum - Cooling

11

AZAS100MV1
 AZAS100MY1
 RZASG100MV1
 RZASG100MY1

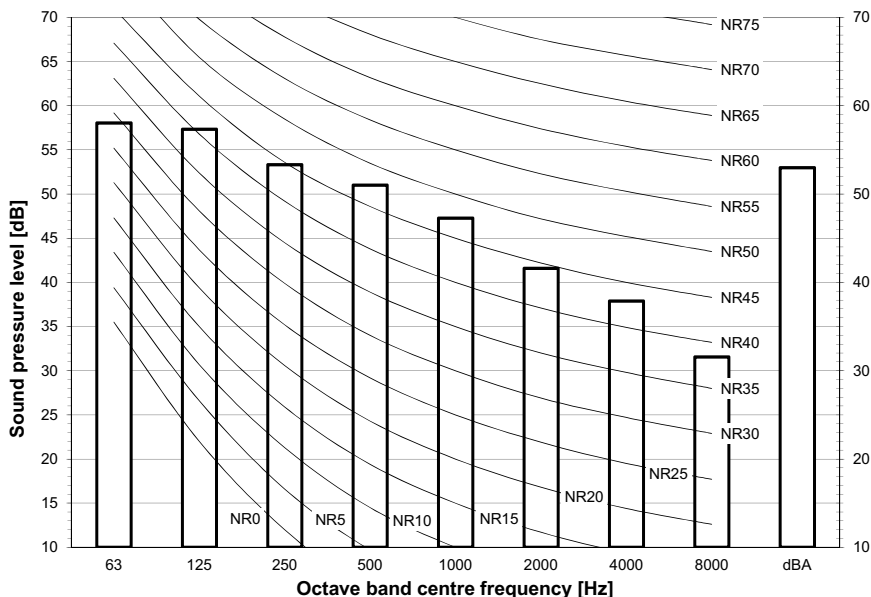

- Notes**
- Data is valid at free field condition.
 - Data is valid at nominal operation condition.
 - dBA = A-weighted sound pressure level (A scale according to IEC).
 - Reference acoustic pressure 0 dB = 20 µPa

3D110050

AZAS125MV1
 AZAS125MY1
 RZASG125MV1
 RZASG125MY1

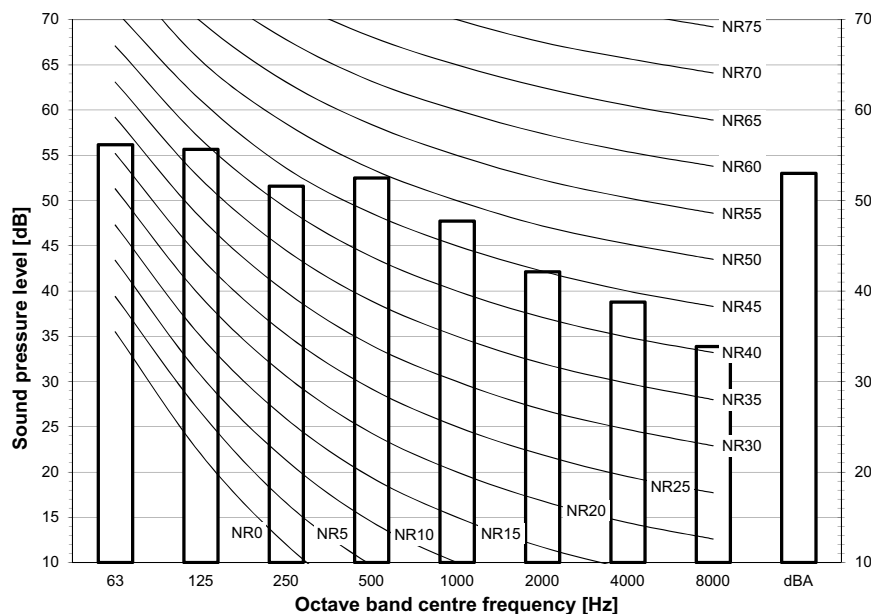

- Notes**
- Data is valid at free field condition.
 - Data is valid at nominal operation condition.
 - dBA = A-weighted sound pressure level (A scale according to IEC).
 - Reference acoustic pressure 0 dB = 20 µPa

3D110051

11 Sound data

11 - 2 Sound Pressure Spectrum - Cooling

AZAS140MV1
 AZAS140MY1
 RZASG140MV1
 RZASG140MY1

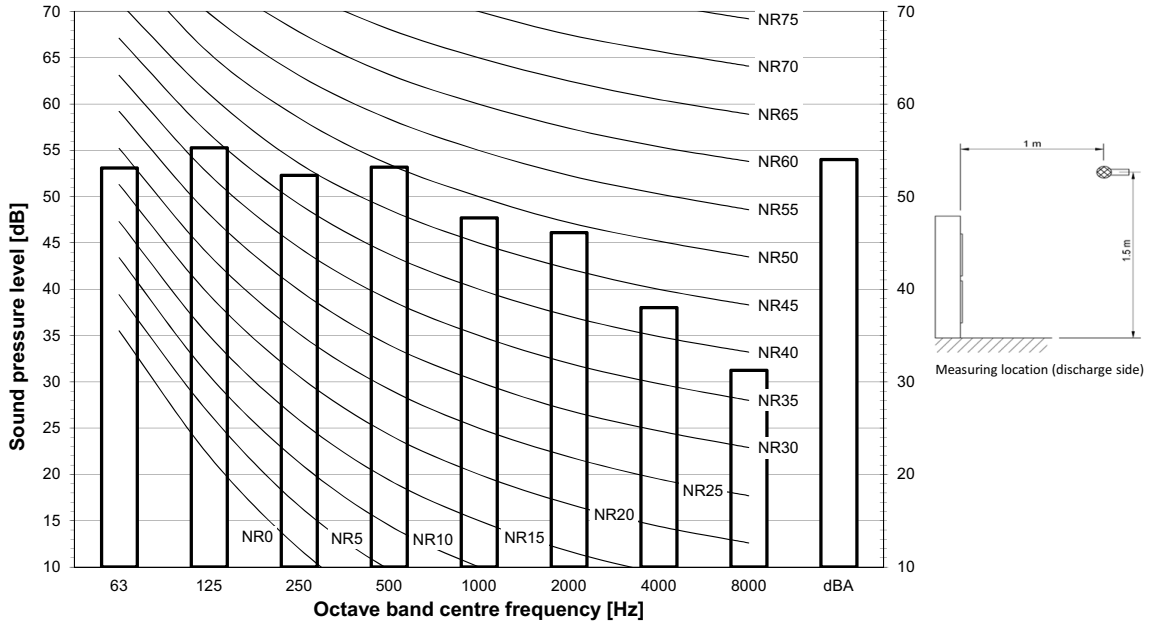

Notes

- Data is valid at free field condition.
- Data is valid at nominal operation condition.
- dBA = A-weighted sound pressure level (A scale according to IEC).
- Reference acoustic pressure 0 dB = 20 μPa

3D111310

11 Sound data

11 - 3 Sound Pressure Spectrum - Heating

11

AZAS100MV1
 AZAS100MY1
 RZASG100MV1
 RZASG100MY1

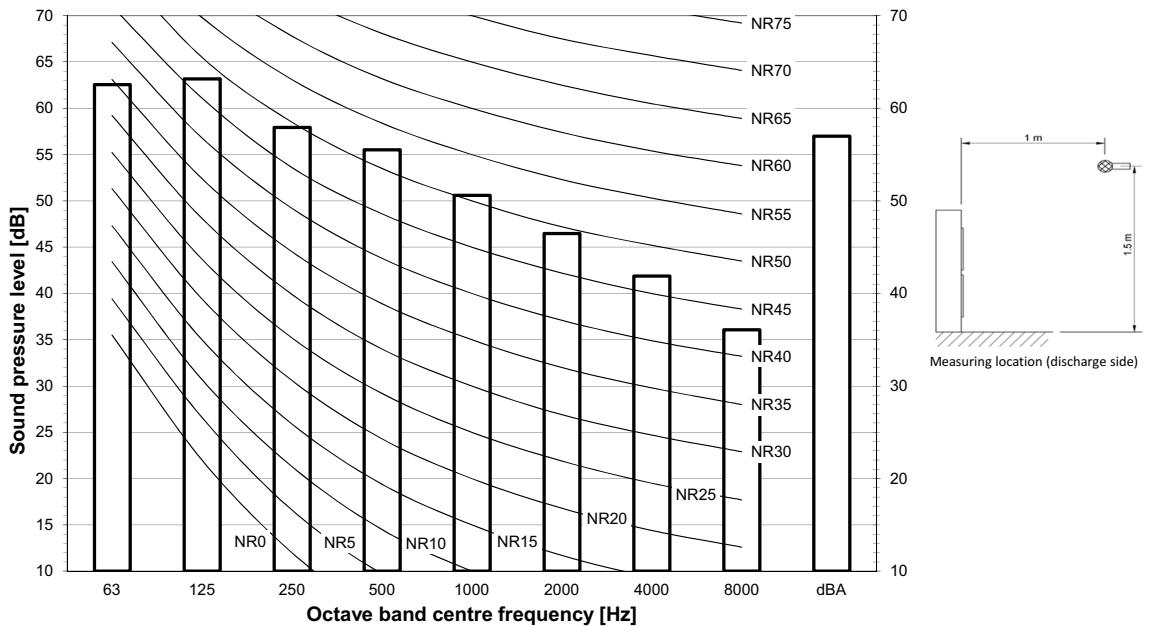

Notes

- Data is valid at free field condition.
- Data is valid at nominal operation condition.
- dBA = A-weighted sound pressure level (A scale according to IEC).
- Reference acoustic pressure 0 dB = 20 µPa

3D111294

AZAS125MV1
 AZAS125MY1
 RZASG125MV1
 RZASG125MY1

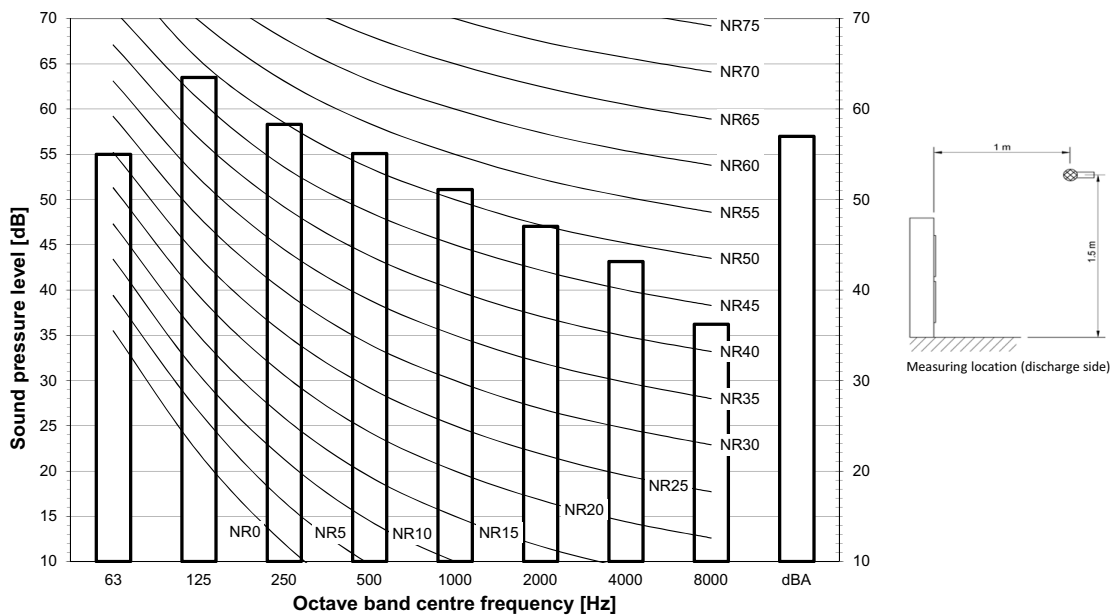

Notes

- Data is valid at free field condition.
- Data is valid at nominal operation condition.
- dBA = A-weighted sound pressure level (A scale according to IEC).
- Reference acoustic pressure 0 dB = 20 µPa

3D111295

20

11 Sound data

11 - 3 Sound Pressure Spectrum - Heating

AZAS140MV1
 AZAS140MY1
 RZASG140MV1
 RZASG140MY1

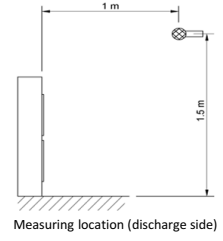
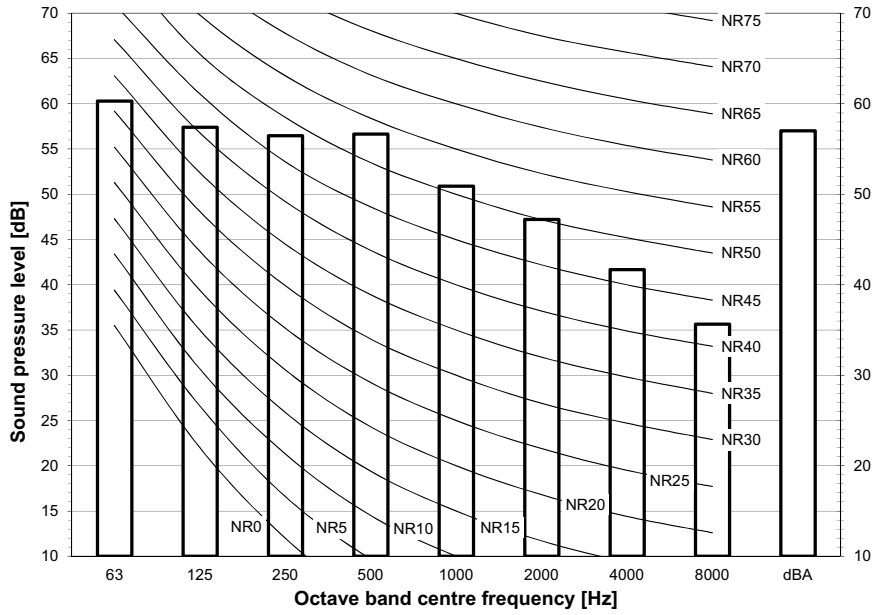

Notes

- Data is valid at free field condition.
- Data is valid at nominal operation condition.
- dBA = A-weighted sound pressure level (A scale according to IEC).
- Reference acoustic pressure 0 dB = 20 μPa

3D111296

11 Sound data

11 - 4 Sound Pressure Spectrum Quiet Mode

11

AZAS100MV1
 AZAS100MY1
 RZASG100MV1
 RZASG100MY1

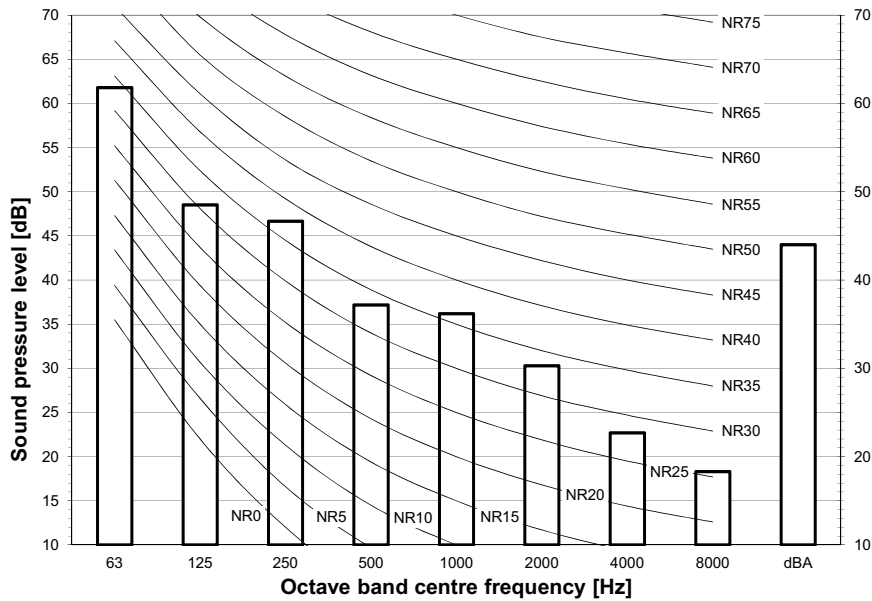

- Notes**
- Data is valid at free field condition.
 - Data is valid at nominal operation condition.
 - dBA = A-weighted sound pressure level (A scale according to IEC).
 - Reference acoustic pressure 0 dB = 20 μPa

3D111316

AZAS125MV1
 AZAS125MY1
 RZASG125MV1
 RZASG125MY1

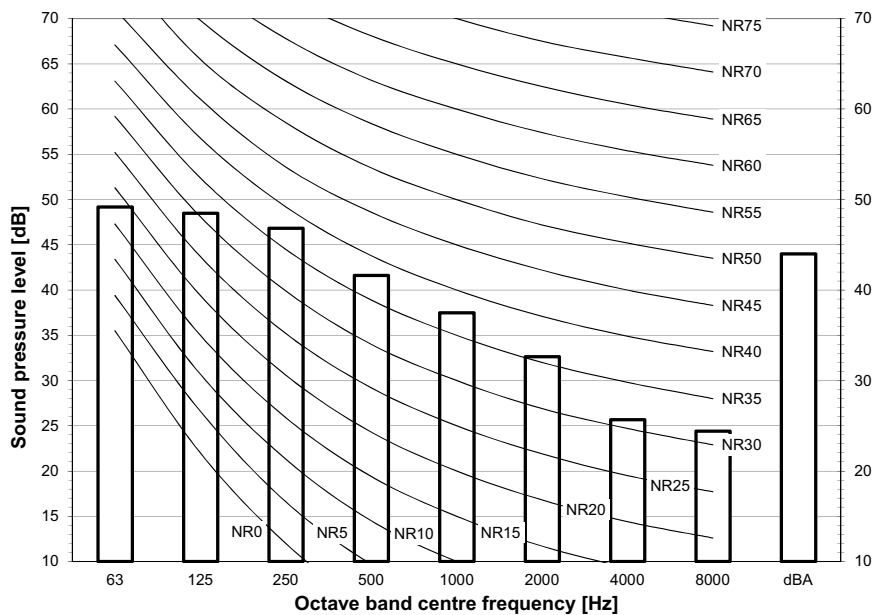

- Notes**
- Data is valid at free field condition.
 - Data is valid at nominal operation condition.
 - dBA = A-weighted sound pressure level (A scale according to IEC).
 - Reference acoustic pressure 0 dB = 20 μPa

3D111317

11 Sound data

11 - 4 Sound Pressure Spectrum Quiet Mode

AZAS140MV1
 AZAS140MY1
 RZASG140MV1
 RZASG140MY1

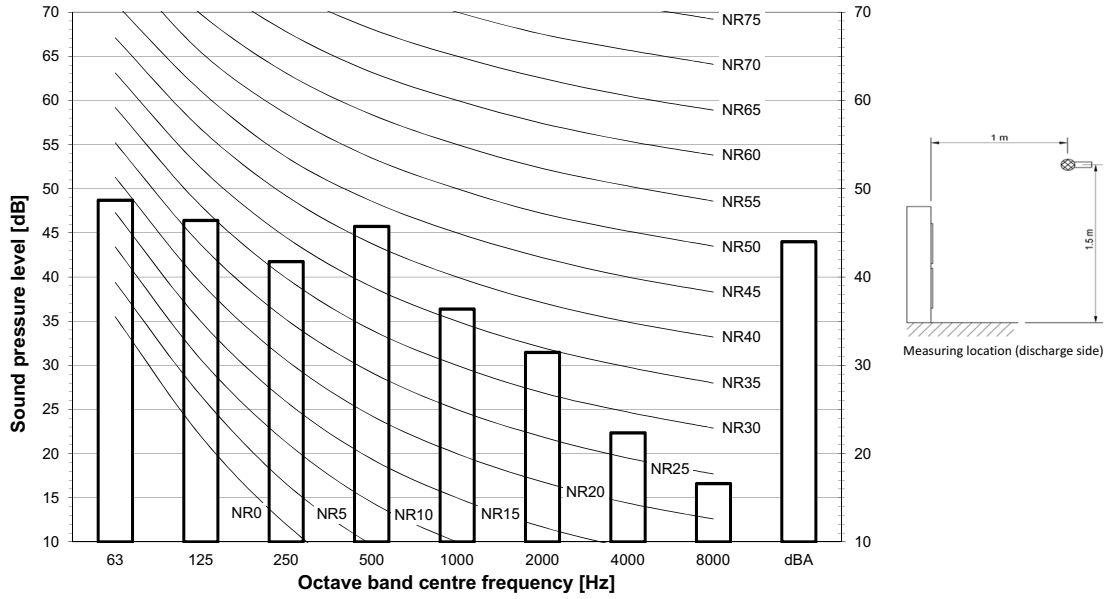

Notes

- Data is valid at free field condition.
- Data is valid at nominal operation condition.
- dBA = A-weighted sound pressure level (A scale according to IEC).
- Reference acoustic pressure 0 dB = 20 μPa

3D111318

12 Installation

12 - 1 Installation Method

RZAG-MV1
 RZAG-MY1
 RZASG-MV1
 RZASG-MY1
 AZAS-MV1
 AZAS-MY1

Installation service space

The measure of these values is "mm".

(A) When there are obstacles on suction sides.

• No obstacle above

- ① Stand-alone installation
 - Obstacle on the suction side only

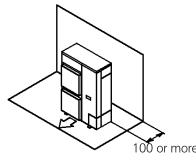

- Obstacle on both sides and suction side, too

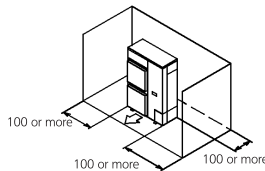

- ② Series installation (2 or more) (Note 1)
 - Obstacle on the suction side and both sides

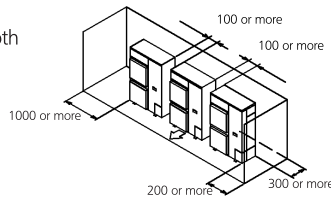

• Obstacle above, too.

- ① Stand-alone installation
 - Obstacle on the suction side, too

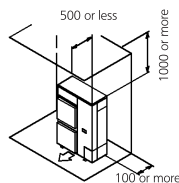

- Obstacle on both sides and suction side, too

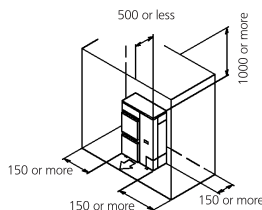

- ② Series installation (2 or more) (Note 1)
 - Obstacle on the suction side and both sides

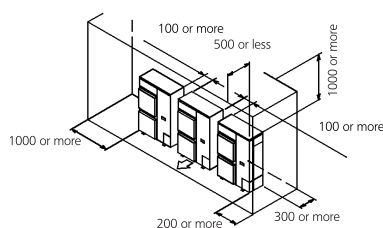

(B) When there are obstacles on discharge sides.

• No obstacle above

- ① Stand-alone installation
 - Obstacle on the discharge side only

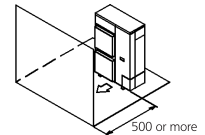

- ② Series installation (2 or more) (Note 1)
 - Obstacle on the discharge side only

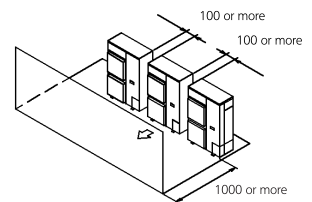

• Obstacle above, too

- ① Stand-alone installation
 - Obstacle on the discharge side only, too

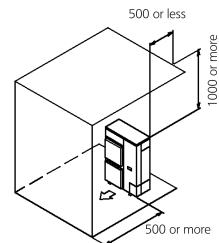

- ② Series installation (2 or more) (Note 1)
 - Obstacle on the discharge side

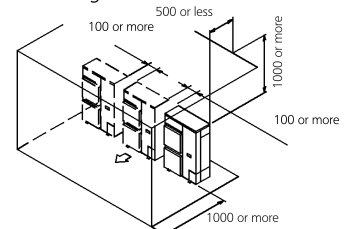

(C) When there are obstacles on both suction and discharge sides.

Pattern 1

When the obstacles on the discharge side is higher than the unit. (L>H)
 (There is no limit for the height of obstructions on the suction side.)

• No obstacle above

- ① Stand-alone installation
 - No obstacle above

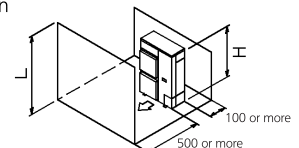

- ② Series installation (2 or more) (Note 1)
 - No obstacle above

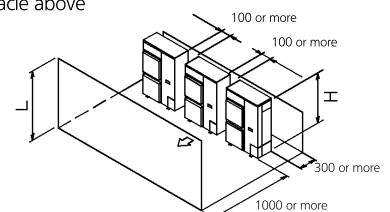

12 Installation

12 - 1 Installation Method

RZAG-MV1
 RZAG-MY1
 RZASG-MV1
 RZASG-MY1
 AZAS-MV1
 AZAS-MY1

• Obstacle above, too

- ① Stand-alone installation (Note 2)
 - When there are obstacles on suction, discharge and top sides.

The relations between H, A and L are as follows.

	L	A
$L \leq H$	$L \leq 1/2 H$ $1/2 H < L \leq H$	750 or more 1000 or more
$L > H$	Set the stand as : $L \leq H$ Refer to the column of $L \leq H$ for A	

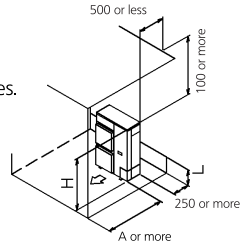

- ② Series installation (2 or more) (Note 1, 2)
 - When there are obstacles on suction, discharge and top sides.

The relations between H, A and L are as follows.

	L	A
$L \leq H$	$L \leq 1/2 H$ $1/2 H < L \leq H$	1000 or more 1250 or more
$L > H$	Set the stand as : $L \leq H$ Refer to the column of $L \leq H$ for A	

Limit of series installation is 2 units.

Pattern 2

When the obstacle on the discharge side is lower than the unit ($L \leq H$) (There is no limit for the height of obstructions on the suction side.)

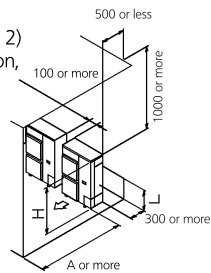

• No obstacle above

- ① Stand-alone installation
 - No obstacle above

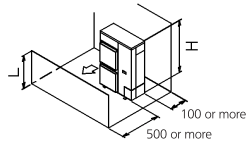

- ② Series installation (2 or more) (Note 1, 2)
 - When there are obstacles on both suction and discharge sides.

The relations between H, A and L are as follows.

	L	A
$L \leq H$	$L \leq 1/2 H$ $1/2 H < L \leq H$	250 or more 300 or more

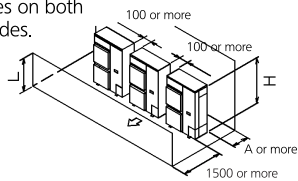

• obstacle above

- ① Stand-alone installation (Note 2)
 - When there are obstacles on suction, discharge and top sides.

The relations between H, A and L are as follows.

	L	A
$L \leq H$	$L \leq 1/2 H$ $1/2 H < L \leq H$	100 or more 200 or more
$L > H$	Set the stand as : $L \leq H$ Refer to the column of $L \leq H$ for A	

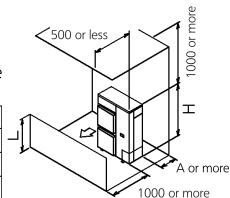

- ② Series installation (2 or more) (Note 1, 2)
 - When there are obstacles on suction, discharge and top sides.

The relations between H, A and L are as follows.

	L	A
$L \leq H$	$L \leq 1/2 H$ $1/2 H < L \leq H$	250 or more 300 or more
$L > H$	Set the stand as : $L \leq H$ Refer to the column of $L \leq H$ for A	

Limit of series installation is 2 units.

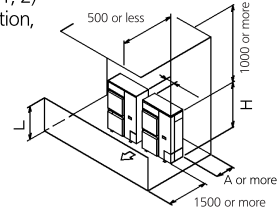

(D) Double-decker installation

- ① Obstacle on the discharge side. (1)
 - Do not exceed two levels for stacked installation.
 - Install a roof cover similar to A (field supply), as outdoor units with downward drainage are prone to dripping and freezing.
 - Install the upper-level outdoor unit so that its bottom plate is a sufficient height above the roof cover. This is to prevent the buildup of ice on the underside of the bottom plate.
- ② Obstacle on the suction side. (1)
 - Do not exceed two levels for stacked installation.
 - Install a roof cover similar to A (field supply), as outdoor units with downward drainage are prone to dripping and freezing.
 - Install the upper-level outdoor unit so that its bottom plate is a sufficient height above the roof cover. This is to prevent the buildup of ice on the underside of the bottom plate.

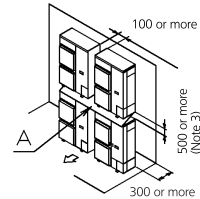
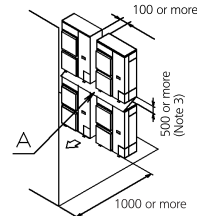

(E) Multiple rows of series installation (on the rooftop, etc.)

- ① One row of stand-alone installation

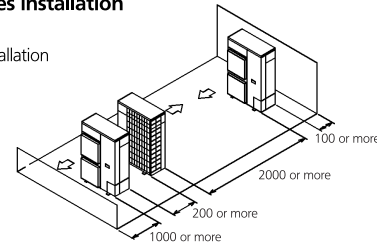

- ② Rows of series installation (2 or more)

The relations between H, A and L are as follows.

	L	A
$L \leq H$	$L \leq 1/2 H$ $1/2 H < L \leq H$	250 or more 300 or more
$L > H$	Can not be installed	

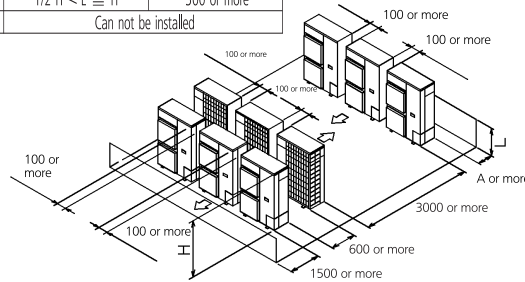

NOTES

- In case of the sideways piping, make a 100mm gap between the unit above.
- Close the bottom of the installation frame to prevent the discharged air from being bypassed.
- It is not necessary to install a roof cover if there is no danger of drainage dripping and freezing. In this case, the space between the upper and lower outdoor units should be at least 100mm. Close off the gap between the upper and lower units so there is no re-intake of discharged air.

13 Operation range

13 - 1 Operation Range

13

AZAS-MV1 AZAS-MY1

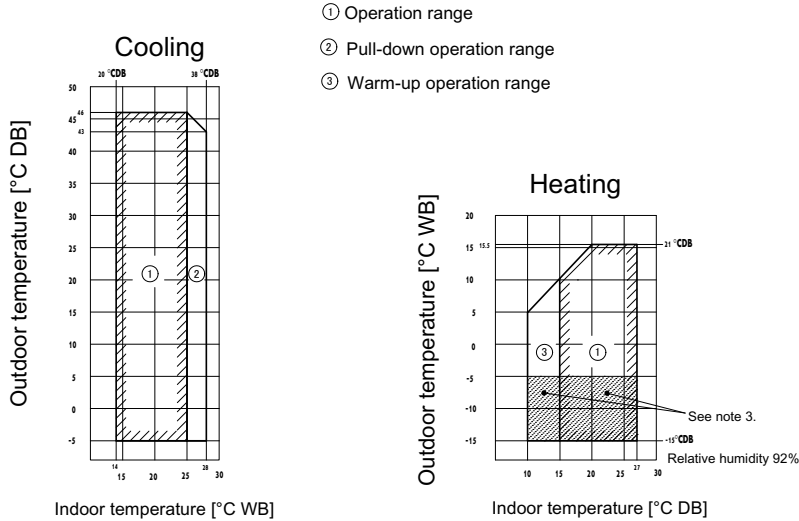

Notes

1. Depending on operation and installation conditions, the indoor unit can change over to freeze-up operation (indoor de-icing).
2. To reduce the freeze-up operation (indoor de-icing) frequency, it is recommended to install the outdoor unit in a location not exposed to wind.
3. In case of high humidity conditions (> 92%) at ambient temperatures of < -5°C, a RZAG model should be used instead to avoid freeze-up of the outdoor unit.

3D111298