

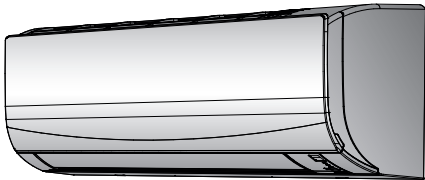

User reference guide

# Daikin room air conditioner



FTXF20C5V1B  
FTXF25C5V1B  
FTXF35C5V1B  
FTXF42C5V1B  
ATXF20C5V1B  
ATXF25C5V1B  
ATXF35C5V1B  
ATXF42C5V1B

# Table of contents

<b>1</b>	<b>General safety precautions</b>	<b>3</b>
1.1	About the documentation .....	3
1.1.1	Meaning of warnings and symbols .....	3
1.2	For the user .....	4
<b>2</b>	<b>About the documentation</b>	<b>6</b>
2.1	About this document .....	6
2.2	User reference guide at a glance .....	6
<b>3</b>	<b>About the system</b>	<b>8</b>
3.1	Indoor unit .....	8
3.2	About the user interface .....	9
3.2.1	Components: User interface .....	10
3.2.2	Status: User interface LCD .....	10
3.2.3	To operate the user interface .....	11
<b>4</b>	<b>Before operation</b>	<b>12</b>
4.1	Overview: Before operation .....	12
4.2	To mount the user interface holder .....	12
4.3	To insert the batteries .....	12
4.4	To turn on the power supply .....	13
<b>5</b>	<b>Operation</b>	<b>14</b>
5.1	Operation range .....	14
5.2	When to use which feature .....	14
5.3	Operation mode and temperature setpoint .....	15
5.3.1	To start/stop operation mode and to set the temperature .....	15
5.3.2	Airflow rate .....	16
5.3.3	Airflow direction .....	16
5.3.4	Comfort airflow operation .....	17
5.3.5	Powerful operation .....	18
5.3.6	Econo operation .....	19
5.3.7	OFF/ON timer operation .....	19
<b>6</b>	<b>Energy saving and optimum operation</b>	<b>21</b>
<b>7</b>	<b>Maintenance and service</b>	<b>23</b>
7.1	Overview: Maintenance and service .....	23
7.2	To clean the indoor unit and user interface .....	24
7.3	To clean the front panel .....	25
7.4	About the air filters .....	25
7.5	To clean the air filters .....	25
7.6	To take following items into account before a long idle period .....	26
<b>8</b>	<b>Troubleshooting</b>	<b>27</b>
8.1	Symptoms that are NOT system malfunctions .....	29
8.1.1	Symptom: A sound like water flowing is heard .....	29
8.1.2	Symptom: A blowing sound is heard .....	29
8.1.3	Symptom: A ticking sound is heard .....	29
8.1.4	Symptom: A whistling sound is heard .....	29
8.1.5	Symptom: A clicking sound during operation or idle time is heard .....	29
8.1.6	Symptom: A clapping sound is heard .....	29
8.1.7	Symptom: The units can give off odours .....	29
8.1.8	Symptom: The outdoor fan rotates while the air conditioner is not in operation .....	29
8.2	Solving problems based on error codes .....	30
<b>9</b>	<b>Disposal</b>	<b>32</b>
<b>10</b>	<b>Glossary</b>	<b>33</b>

# 1 General safety precautions

## 1.1 About the documentation

- The original documentation is written in English. All other languages are translations.
- The precautions described in this document cover very important topics, follow them carefully.
- The installation of the system, and all activities described in the installation manual and in the installer reference guide **MUST** be performed by an authorised installer.

### 1.1.1 Meaning of warnings and symbols



#### **DANGER**

Indicates a situation that results in death or serious injury.



#### **DANGER: RISK OF ELECTROCUTION**

Indicates a situation that could result in electrocution.



#### **DANGER: RISK OF BURNING/SCALDING**

Indicates a situation that could result in burning/scalding because of extreme hot or cold temperatures.



#### **DANGER: RISK OF EXPLOSION**

Indicates a situation that could result in explosion.



#### **WARNING**

Indicates a situation that could result in death or serious injury.



#### **WARNING: FLAMMABLE MATERIAL**



#### **CAUTION**

Indicates a situation that could result in minor or moderate injury.



#### **NOTICE**





Indicates a situation that could result in equipment or property damage.





#### **INFORMATION**

Indicates useful tips or additional information.

Symbols used on the unit:

Symbol	Explanation
	Before installation, read the installation and operation manual, and the wiring instruction sheet.
	Before performing maintenance and service tasks, read the service manual.
	For more information, see the installer and user reference guide.
	The unit contains rotating parts. Be careful when servicing or inspecting the unit.

Symbols used in the documentation:

Symbol	Explanation
	Indicates a figure title or a reference to it. <b>Example:</b> "▲ 1-3 Figure title" means "Figure 3 in chapter 1".
	Indicates a table title or a reference to it. <b>Example:</b> "■ 1-3 Table title" means "Table 3 in chapter 1".

## 1.2 For the user



### WARNING

If you are NOT sure how to operate the unit, contact your installer.



### WARNING

This appliance can be used by children aged from 8 years and above and persons with reduced physical, sensory or mental capabilities or lack of experience and knowledge if they have been given supervision or instruction concerning use of the appliance in a safe way and understand the hazards involved.

Children SHALL NOT play with the appliance.

Cleaning and user maintenance SHALL NOT be made by children without supervision.



### WARNING

To prevent electrical shocks or fire:

- Do NOT rinse the unit.
- Do NOT operate the unit with wet hands.
- Do NOT place any objects containing water on the unit.

**CAUTION**

- Do NOT place any objects or equipment on top of the unit.
- Do NOT sit, climb or stand on the unit.

- Units are marked with the following symbol:



This means that electrical and electronic products may NOT be mixed with unsorted household waste. Do NOT try to dismantle the system yourself: the dismantling of the system, treatment of the refrigerant, of oil and of other parts MUST be done by an authorised installer and MUST comply with applicable legislation.

Units MUST be treated at a specialised treatment facility for reuse, recycling and recovery. By ensuring this product is disposed of correctly, you will help to prevent potential negative consequences for the environment and human health. For more information, contact your installer or local authority.

- Batteries are marked with the following symbol:



This means that the batteries may NOT be mixed with unsorted household waste. If a chemical symbol is printed beneath the symbol, this chemical symbol means that the battery contains a heavy metal above a certain concentration.

Possible chemical symbols are: Pb: lead (>0.004%).

Waste batteries MUST be treated at a specialised treatment facility for reuse. By ensuring waste batteries are disposed of correctly, you will help to prevent potential negative consequences for the environment and human health.

## 2 About the documentation

### 2.1 About this document

Thank you for purchasing this product. Please:

- Keep the documentation for future reference.

#### Target audience

End users



#### INFORMATION

This appliance is intended to be used by expert or trained users in shops, in light industry, and on farms, or for commercial and household use by lay persons.

#### Documentation set

This document is part of a documentation set. The complete set consists of:

- **General safety precautions:**
  - Safety instructions that you must read before operating your system
  - Format: Paper (in the box of the indoor unit)
- **Operation manual:**
  - Quick guide for basic usage
  - Format: Paper (in the box of the indoor unit)
- **User reference guide:**
  - Detailed step-by-step instructions and background information for basic and advanced usage
  - Format: Digital files on <http://www.daikineurope.com/support-and-manuals/product-information/>

Latest revisions of the supplied documentation may be available on the regional Daikin website or via your installer.

The original documentation is written in English. All other languages are translations.

### 2.2 User reference guide at a glance

Chapter	Description
General safety precautions	Safety instructions that you MUST read before operation
About the documentation	What documentation exists for the user
About the system	<ul style="list-style-type: none"> <li>▪ Operation range</li> <li>▪ Description of indoor unit and user interface</li> </ul>
Before operation	What to do before starting operation
Operation	How and when to use certain features

Chapter	Description
Energy saving and optimum operation	How to save energy
Maintenance and service	How to maintain and service the unit
Troubleshooting	What to do in case of problems
Disposal	How to dispose of the system
Glossary	Definition of terms

## 3 About the system



### NOTICE

Do NOT use the system for other purposes. In order to avoid any quality deterioration, do NOT use the unit for cooling precision instruments, food, plants, animals, or works of art.

### 3.1 Indoor unit



### CAUTION

Do NOT insert fingers, rods or other objects into the air inlet or outlet. When the fan is rotating at high speed, it will cause injury.



### INFORMATION

The sound pressure level is less than 70 dBA.



### WARNING

- Do NOT modify, disassemble, remove, reinstall or repair the unit yourself as incorrect dismantling or installation may cause an electrical shock or fire. Contact your dealer.
- In case of accidental refrigerant leaks, make sure there are no naked flames. The refrigerant itself is entirely safe, non-toxic and mildly flammable, but it will generate toxic gas when it accidentally leaks into a room where combustible air from fan heaters, gas cookers, etc. is present. Always have qualified service personnel confirm that the point of leakage has been repaired or corrected before resuming operation.



### INFORMATION

The following figures are just examples and may NOT completely match your system layout.

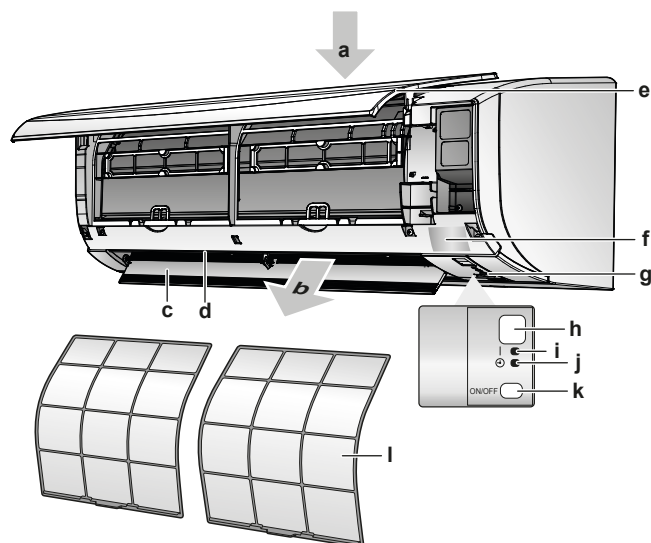

- a Air inlet
- b Air outlet
- c Flap (horizontal blade)
- d Louvers (vertical blades)
- e Front panel



- f** Model name plate
- g** Room temperature sensor
- h** Signal receiver
- i** Operation indicator (green)
- j** Timer lamp (orange)
- k** Indoor unit ON/OFF switch
- l** Air filter

### ON/OFF button

If the user interface is missing, you can use the ON/OFF button on the indoor unit to start/stop operation. When operation is started using this button, the following settings are used:

- Operation mode = Automatic
- Temperature setting = 25°C
- Airflow rate = Automatic

## 3.2 About the user interface

- **Direct sunlight.** Do NOT expose the user interface to direct sunlight.
- **Dust.** Dust on the signal transmitter or receiver will reduce sensitivity. Wipe off dust with a soft cloth.
- **Fluorescent lights.** Signal communication might be disabled if fluorescent lamps are in the room. In that case, contact your installer.
- **Other appliances.** If the user interface signals operate other appliances, move the other appliances, or contact your installer.
- **Curtains.** Make sure that the signal between the unit and the user interface is NOT blocked by curtains or other objects.



#### NOTICE

- Do NOT drop the user interface.
- Do NOT let the user interface get wet.

3.2.1 Components: User interface

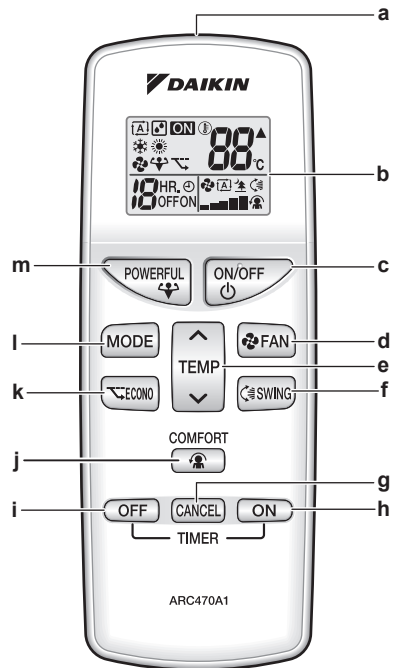

- a Signal transmitter
- b LCD display
- c ON/OFF button
- d Fan setting button
- e Temperature adjustment button
- f Swing button
- g Timer cancel button
- h ON timer button
- i OFF timer button
- j Comfort airflow button
- k Econo button
- l Mode selector button
- m Powerful button

3.2.2 Status: User interface LCD

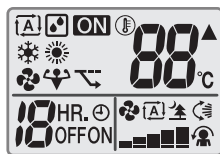

Icon	Description
	Operation mode = Automatic
	Operation mode = Drying
	Operation mode = Heating
	Operation mode = Cooling
	Operation mode = Fan only
	Powerful operation is active
	Econo operation is active
	Operation is active

Icon	Description
▲	The indoor unit receives a signal from the user interface
Ⓢ 88°C	Current temperature setting
🌀 [A]	Airflow rate = Automatic
🌀 🌳	Airflow rate = Indoor unit quiet
🌀 📊	Airflow rate = High
🌀 📊	Airflow rate = Medium high
🌀 📊	Airflow rate = Medium
🌀 📊	Airflow rate = Medium low
🌀 📊	Airflow rate = Low
👤	Comfort operation is active
🔄	Auto vertical swing is active
🕒 HR.Ⓢ ON	ON timer is active
🕒 HR.Ⓢ OFF	OFF timer is active

### 3.2.3 To operate the user interface

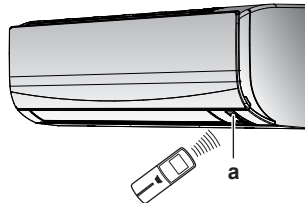

a Signal receiver

- 1 Aim the signal transmitter at the signal receiver on the indoor unit (maximum distance for communication is 7 m).

**Result:** When the indoor unit receives a signal from the user interface, you will hear a sound:

Sound	Description
Beep-beep	Operation starts.
Beep	Setting changes.
Long beep	Operation stops.

## 4 Before operation

### 4.1 Overview: Before operation

This chapter describes what you have to do before operating the unit.

#### Typical workflow

Before operation usually consist of the following stages:

- Inserting the batteries in the user interface.
- Fixing the user interface to the wall.
- Turning on the power supply.

### 4.2 To mount the user interface holder

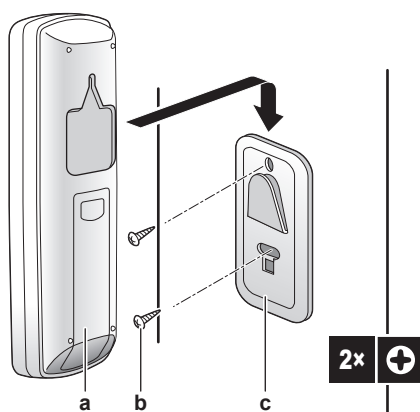

- a** User interface
- b** Screws (field supply)
- c** User interface holder

- 1 Choose a place where the signals reach the unit.
- 2 Attach the holder with screws to the wall or a similar location.
- 3 Hang the user interface on the user interface holder.

### 4.3 To insert the batteries

The batteries will last for about 1 year.

- 1 Remove the back cover.
- 2 Insert both batteries at once.
- 3 Put the cover back.

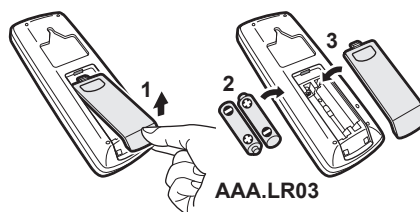

## 4.4 To turn on the power supply

- 1 Turn the circuit breaker on.

**Result:** The flap of the indoor unit will open and close to set the reference position.

# 5 Operation

## 5.1 Operation range







Operation mode	Operation range
Cooling <sup>(a)(b)</sup>	<ul style="list-style-type: none"> <li>▪ Outdoor temperature: -10~46°C DB</li> <li>▪ Indoor temperature: 18~32°C DB</li> <li>▪ Indoor humidity: ≤80%</li> </ul>
Heating <sup>(a)</sup>	<ul style="list-style-type: none"> <li>▪ Outdoor temperature: -15~24°C DB</li> <li>▪ Indoor temperature: 10~30°C DB</li> </ul>
Drying <sup>(a)</sup>	<ul style="list-style-type: none"> <li>▪ Outdoor temperature: -10~46°C DB</li> <li>▪ Indoor temperature: 18~32°C DB</li> <li>▪ Indoor humidity: ≤80%</li> </ul>



<sup>(a)</sup> A safety device might stop the operation of the system if the unit runs outside its operation range.

<sup>(b)</sup> Condensation and water dripping might occur if the unit runs outside its operation range.

## 5.2 When to use which feature

You can use the following table to determine which features to use:

Feature	Tasks
<b>Basic features</b>	
 Operation modes and temperature	To start/stop the system and to set the temperature: <ul style="list-style-type: none"> <li>▪ Heat up or cool down a room.</li> <li>▪ Blow air in a room without heating or cooling.</li> <li>▪ Decrease the humidity in a room.</li> <li>▪ In Automatic mode, automatically select an appropriate temperature and operation mode.</li> </ul>
 Airflow direction	To adjust the airflow direction (swing or fixed position).
 Airflow rate	To adjust the amount of air blown into the room. To run more quietly.
<b>Advanced features</b>	
 Econo	To use the system when you are also using other power-consuming appliances. To save energy.
 Comfort	To provide a comfortable airflow that does NOT come in direct contact with people.
 Powerful	To cool down or heat up the room quickly.





Feature	Tasks
 ON timer +  OFF timer	To automatically turn ON or OFF the system.

### 5.3 Operation mode and temperature setpoint

**When.** Adjust the system operation mode and set the temperature when you want to:

- Heat up or cool down a room
- Blow air in a room without heating or cooling
- Decrease the humidity in a room

**What.** The system operates differently, depending on the user selection.

Setting	Description
 Automatic	The system cools down or heats up a room to the temperature setpoint. It automatically switches between cooling and heating if necessary.
 Drying	The system decreases the humidity in a room.
 Heating	The system heats up a room to the temperature setpoint.
 Cooling	The system cools down a room to the temperature setpoint.
 Fan	The system only controls the airflow (airflow rate and airflow direction). The system does NOT control the temperature.

**Additional info:**

- **Outside temperature.** The system's cooling or heating effect decreases when the outside temperature is too high or too low.
- **Defrost operation.** During heating operation, frost might occur on the outdoor unit and decrease the heating capacity. In that case, the system automatically switches to defrosting operation to remove the frost. During defrosting operation, hot air is NOT blown from the indoor unit.

#### 5.3.1 To start/stop operation mode and to set the temperature

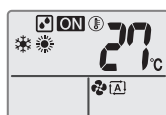

**ON**: Unit is operating.

**A**: Operation mode = Automatic

: Operation mode = Drying

: Operation mode = Heating

: Operation mode = Cooling

: Operation mode = Fan only

**27**: Shows the set temperature.

- 1 Press  one or more times to select the operation mode.

**Result:** The mode will be set in the following sequence:



- 2 Press  to **start** operation.

**Result:** **ON** is displayed on the LCD.

**Result:** The operation lamp lights up.

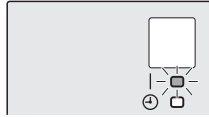

- 3 Press  $\downarrow$  or  $\uparrow$  on the  button one or more times to lower or raise the **temperature**.

**Note:** When using drying or fan only mode, you cannot adjust the temperature.



- 4 Press  to **stop** operation.

**Result:** **ON** disappears from the LCD.

**Result:** The operation lamp goes off.

### 5.3.2 Airflow rate

- 1 Press  to choose:

	5 airflow rate levels, from "■" to "■■■■"
	Automatic airflow rate operation
	Indoor unit quiet operation. When the airflow rate is set to "▲", the noise from the unit will be reduced.

#### To adjust the airflow rate

- 1 Press  to change the airflow setting as follows:



### 5.3.3 Airflow direction

**When.** Adjust the airflow direction as desired.

**What.** The system directs the airflow differently, depending on the user selection (swinging or fixed position). It does so by moving the vertical blades.

Setting	Airflow direction
 Vertical auto swing	Moves up and down.
[—]	Stays in a fixed position.



**CAUTION**

- ALWAYS use a user interface to adjust the angle of the flap. When the flap is swinging and you move it forcibly by hand, the mechanism will break.
- Be careful when adjusting the louvers. Inside the air outlet, a fan is rotating at high speed.

The movable range of the flap varies according to the operation mode. The flap will stop at the upper position when the airflow rate is changed to low during the up and down swing setting.

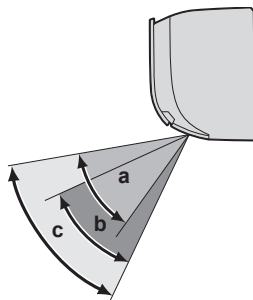

- a Flap range in cooling or drying operation
- b Flap range in heating operation
- c Flap range in fan only operation

**To adjust the louvers (vertical blades)**

- 1 Hold 1 or both knobs and move the louvers.

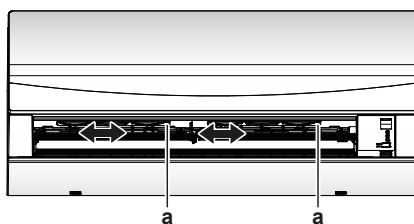

- a Knobs

**INFORMATION**

When the unit is installed in a corner of a room, the direction of the louvers should be facing away from the wall. Efficiency will drop if a wall blocks the air.

## 5.3.4 Comfort airflow operation

This operation can be used in **heating** or **cooling** operation mode. It will provide a comfortable wind that will NOT come in direct contact with people. The system automatically sets the fixed airflow position upward in Cooling and downward in Heating operation mode.

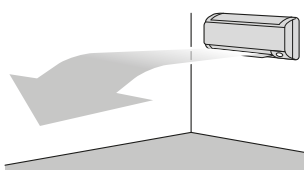
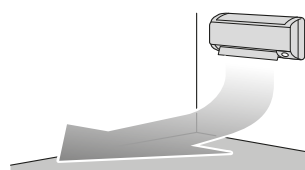
**Cooling operation mode****Heating operation mode**

**INFORMATION**

Powerful and Comfort airflow operation CANNOT be used at the same time. The last selected function takes priority. If the vertical automatic swing is selected, Comfort airflow operation will be cancelled.

**To start/stop Comfort airflow operation**

- 1 Press  to start.

**Result:** The flap position will change,  is displayed on the LCD, and the airflow rate is set to automatic.

Mode	Position of flap...
Cooling/Drying	Up
Heating	Down

- 2 Press  to stop.

**Result:** The flap will return to the position from before the Comfort airflow mode;  disappears from the LCD.

**5.3.5 Powerful operation**

This operation quickly maximizes the cooling/heating effect in any operation mode. You can get the maximum capacity.

Mode	Airflow rate
Cooling/Heating	<ul style="list-style-type: none"> <li>To maximize the cooling/heating effect, the capacity of outdoor unit is increased.</li> <li>The airflow rate is fixed to the maximum setting.</li> <li>The temperature and airflow settings CANNOT be changed.</li> </ul>
Drying	<ul style="list-style-type: none"> <li>The temperature setting is lowered by 2.5°C.</li> <li>The airflow rate is slightly increased.</li> </ul>
Fan only	The airflow rate is fixed to the maximum setting.

**INFORMATION**

Powerful operation CANNOT be used together with Econo and Comfort airflow operation. The last selected function takes priority.

Powerful operation will NOT increase the capacity of the unit if it already operates at maximum capacity.



**To start/stop Powerful operation**

- 1 Press  to start.

**Result:**  is displayed on the LCD. Powerful operation runs for 20 minutes; after that, operation returns to the previously set mode.

2 Press  to stop.

**Result:**  disappears from the LCD.

**Note:** Powerful operation can be set only when the unit is running. If you press  or if you change operation mode, operation will be cancelled;  disappears from the LCD.

### 5.3.6 Econo operation

This is a function which enables efficient operation by limiting the maximum power consumption value. This function is useful for cases in which attention should be paid to ensure a circuit breaker will not trip when the product runs alongside other appliances.



#### INFORMATION

- Powerful and Econo operation CANNOT be used at the same time. The last selected function takes priority.
- Econo operation reduces power consumption of the outdoor unit by limiting the rotation speed of the compressor. If power consumption is already low, Econo operation will NOT further reduce power consumption.

#### To start/stop Econo operation

1 Press  to start.

**Result:**  is displayed on the LCD.

2 Press  to stop.

**Result:**  disappears from the LCD.

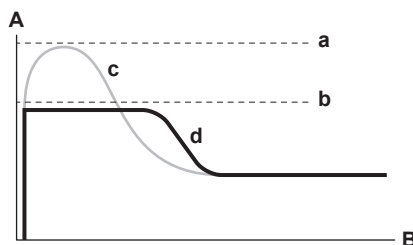

- A** Running current and power consumption
- B** Time
- a** Maximum during normal operation
- b** Maximum during Econo operation
- c** Normal operation
- d** Econo operation

- The diagram is for illustrative purposes only.
- The maximum running current and power consumption of the air conditioner in Econo operation varies with the connected outdoor unit.

### 5.3.7 OFF/ON timer operation

Timer functions are useful for automatically switching the air conditioner off/on at night or in the morning. You can also use OFF timer and ON timer in combination.

**INFORMATION**

Program the timer again in case of:

- A breaker has turned the unit off.
- A power failure.
- After replacing batteries in the user interface.

**To start/stop ON timer operation**

- 1 Press **ON** to start.

**Result:** is displayed on the LCD and the timer lamp lights up.

**INFORMATION**

Each time **ON** is pressed, the time setting advances by 1 hour. The timer can be set between 1 to 12 hours.

- 2 Press **CANCEL** to stop.

**Result:** disappears from the LCD and the timer lamp goes off.

**To start/stop OFF timer operation**

Use this feature if the unit is operating and you want to stop operation after a certain time.

- 1 Press **OFF** to start.

**Result:** is displayed on the LCD and the timer lamp lights up.

**INFORMATION**

Each time **OFF** is pressed, the time setting advances by 1 hour. The timer can be set between 1 to 9 hours.

- 2 Press **OFF** to stop.

**Result:** disappears from the LCD and the timer lamp goes off.

**INFORMATION**

When you set the ON/OFF timer, the time setting is stored in the memory. The memory will be reset when the user interface batteries are replaced.

**Use of night set mode in combination with OFF timer**

The air conditioner automatically adjusts the temperature setting (0.5°C up in cooling, 2.0°C down in heating) to prevent excessive cooling/heating and ensure a comfortable sleeping temperature.

**To combine OFF timer and ON timer**

- 1 To set the timers, refer to "[To start/stop OFF timer operation](#)" [▶ 20] and "[To start/stop ON timer operation](#)" [▶ 20].

**Result:** **OFF** and **ON** are displayed on the LCD.

- 2 Example of what is displayed on the LCD if you combine the 2 timers:



## 6 Energy saving and optimum operation



### INFORMATION

- Even if the unit is turned OFF, it consumes electricity.
- When the power turns back on after a power break, the previously selected mode will be resumed.



### CAUTION

NEVER expose little children, plants or animals directly to the airflow.



### NOTICE

Do NOT place objects below the indoor and/or outdoor unit that may get wet. Otherwise condensation on the unit or refrigerant pipes, air filter dirt or drain blockage may cause dripping, and objects under the unit may get dirty or damaged.



### WARNING

Do NOT place a flammable spray bottle near the air conditioner and do NOT use sprays near the unit. Doing so may result in a fire.



### CAUTION

Do NOT operate the system when using a room fumigation-type insecticide. Chemicals could collect in the unit, and endanger the health of people who are hypersensitive to chemicals.

Observe the following precautions to ensure the system operates properly.

- Prevent direct sunlight from entering a room during cooling operation by using curtains or blinds.
- Make sure the area is well ventilated. Do NOT block any ventilation openings.
- Ventilate often. Extended use requires special attention to ventilation.
- Keep doors and windows closed. If the doors and windows remain open, air will flow out of your room causing a decrease in the cooling or heating effect.
- Be careful NOT to cool or heat too much. To save energy, keep the temperature setting at a moderate level.
- NEVER place objects near the air inlet or the air outlet of the unit. Doing so may cause a reduced heating/cooling effect or stop operation.
- Turn the breaker off when the unit is NOT used for longer periods of time. If the breaker is on, the unit consumes electricity. Before restarting the unit, turn the breaker on 6 hours before operation to ensure smooth running.
- Condensation may form if the humidity is above 80% or if the drain outlet gets blocked.
- Adjust the room temperature properly for a comfortable environment. Avoid excessive heating or cooling. Notice that it may take some time for the room temperature to reach the set temperature. Consider using the timer setting options.
- Adjust the air flow direction to avoid cool air from gathering on the floor or warm air against the ceiling. (Up during cooling or dry operation to the ceiling and down during heating operation.)
- Avoid direct air flow to room inhabitants.

- Operate the system within the recommended temperature range (26~28°C for cooling and 20~24°C for heating) to save energy.

# 7 Maintenance and service

## 7.1 Overview: Maintenance and service

The installer has to perform a yearly maintenance.

### About the refrigerant

This product contains fluorinated greenhouse gases. Do NOT vent gases into the atmosphere.

Refrigerant type: R32

Global warming potential (GWP) value: 675



#### NOTICE

Applicable legislation on **fluorinated greenhouse gases** requires that the refrigerant charge of the unit is indicated both in weight and CO<sub>2</sub> equivalent.

**Formula to calculate the quantity in CO<sub>2</sub> equivalent tonnes:** GWP value of the refrigerant × total refrigerant charge [in kg] / 1000

Please contact your installer for more information.



#### WARNING

The refrigerant inside the unit is mildly flammable, but normally does NOT leak. If the refrigerant leaks in the room and comes in contact with fire from a burner, a heater, or a cooker, this may result in fire, or the formation of a harmful gas.

Turn off any combustible heating devices, ventilate the room, and contact the dealer where you purchased the unit.

Do NOT use the unit until a service person confirms that the part from which the refrigerant leaked has been repaired.



#### WARNING

- Do NOT pierce or burn refrigerant cycle parts.
- Do NOT use cleaning materials or means to accelerate the defrosting process other than those recommended by the manufacturer.
- Be aware that the refrigerant inside the system is odourless.



#### WARNING

The appliance shall be stored in a room without continuously operating ignition sources (example: open flames, an operating gas appliance or an operating electric heater).



#### NOTICE

Maintenance **MUST** be done by an authorised installer or service agent.

We recommend performing maintenance at least once a year. However, applicable legislation might require shorter maintenance intervals.



#### DANGER: RISK OF ELECTROCUTION

To clean the air conditioner or air filter, be sure to stop operation and turn all power supplies OFF. Otherwise, an electrical shock and injury may result.



### WARNING

To prevent electrical shocks or fire:

- Do NOT rinse the unit.
- Do NOT operate the unit with wet hands.
- Do NOT place any objects containing water on the unit.



### CAUTION

After a long use, check the unit stand and fitting for damage. If damaged, the unit may fall and result in injury.



### CAUTION

Do NOT touch the heat exchanger fins. These fins are sharp and could result in cutting injuries.



### WARNING

Be careful with ladders when working in high places.



### NOTICE

Maintenance **MUST** be done by an authorized installer or service agent.

Use Daikin service parts only.

We recommend performing maintenance at least once a year. However, applicable legislation might require shorter maintenance intervals.

## 7.2 To clean the indoor unit and user interface



### NOTICE

- Do NOT use gasoline, benzene, thinner, polishing powder or liquid insecticide. **Possible consequence:** Discoloration and deformation.
- Do NOT use water or air of 40°C or higher. **Possible consequence:** Discoloration and deformation.
- Do NOT use polishing compounds.
- Do NOT use a scrubbing brush. **Possible consequence:** The surface finishing peels off.
- As an end user, you may NEVER clean inside parts of the unit by yourself; this work must be performed by a qualified service person. Contact your dealer.



### DANGER: RISK OF ELECTROCUTION

Before cleaning, be sure to stop the operation, turn the breaker OFF or pull out the supply cord. Otherwise, an electrical shock and injury may result.

- 1 Clean with a soft cloth. If it is difficult to remove stains, use water or a neutral detergent.



### 7.3 To clean the front panel

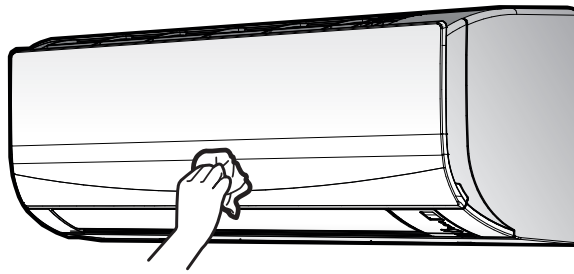

- 1 Clean the front panel with a soft cloth. If it is difficult to remove stains, use water or a neutral detergent.

### 7.4 About the air filters

Operating the unit with dirty filters means that the filter:

- CANNOT deodorise the air,
- CANNOT clean the air,
- poor heating/cooling,
- causes odour.

### 7.5 To clean the air filters

- 1 Push the tab at the centre of each air filter, then pull it down.
- 2 Pull out the air filters.

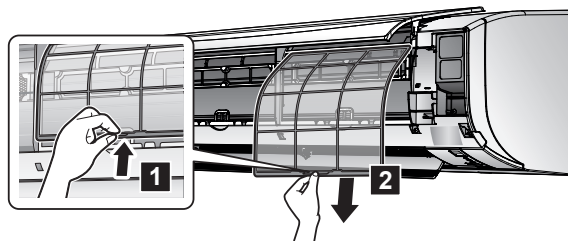

- 3 Wash the air filters with water or clean them with a vacuum cleaner.

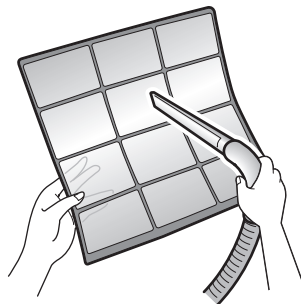

- 4 Soak in lukewarm water for about 10 to 15 minutes.

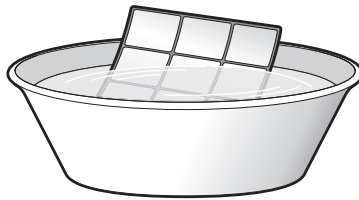

- 5 Install all filters back in their original positions.





#### INFORMATION

- If the dust does NOT come off easily, wash them with a neutral detergent diluted in lukewarm water. Dry the air filters in the shade.
- It is recommended to clean the air filters every 2 weeks.

## 7.6 To take following items into account before a long idle period

Operate the unit in **fan only** mode for several hours to dry the inside of the unit.

- 1 Press  and select fan only operation.
- 2 Press  to start operation.
- 3 After operation stops, turn the breaker off.
- 4 Clean the air filters and replace them in their original position.
- 5 Remove the batteries from the user interface.



#### INFORMATION

It is recommended to have periodical maintenance performed by a specialist. For specialist maintenance, contact your dealer. Maintenance costs shall be borne by the customer.

In certain operating conditions the inside of the unit may get dirty after several seasons of use. This results in poor performance.

## 8 Troubleshooting

If one of the following malfunctions occur, take the measures shown below and contact your dealer.



### WARNING

**Stop operation and shut OFF the power if anything unusual occurs (burning smells etc.).**

Leaving the unit running under such circumstances may cause breakage, electrical shock or fire. Contact your dealer.

The system **MUST** be repaired by a qualified service person.

Malfunction	Measure
If a safety device such as a fuse, a breaker or an earth leakage breaker frequently actuates or the ON/OFF switch does NOT properly work.	Turn OFF the main power switch.
If water leaks from the unit.	Stop the operation.
The operation switch does NOT work well.	Turn OFF the power supply.
If the user interface display indicates the unit number, the operation lamp flashes and the malfunction code appears.	Notify your installer and report the malfunction code.

If the system does NOT operate properly except for the above mentioned cases and none of the above mentioned malfunctions is evident, investigate the system in accordance with the following procedures.

Malfunction	Measure
If the system does NOT operate at all.	<ul style="list-style-type: none"> <li>▪ Check if there is no power failure. Wait until power is restored. If a power failure occurs during operation, the system automatically restarts immediately after power is restored.</li> <li>▪ Check if no fuse has blown or breaker is activated. Change the fuse or reset the breaker if necessary.</li> <li>▪ Check the batteries of the user interface.</li> </ul>
The system suddenly stops operating.	<ul style="list-style-type: none"> <li>▪ Check if the air inlet or outlet of the outdoor or indoor unit is NOT blocked by obstacles. Remove any obstacles and make sure the air can flow freely.</li> <li>▪ The air conditioner may stop operating after sudden large voltage fluctuations to protect the system. It automatically resumes operation after about 3 minutes.</li> </ul>

Malfunction	Measure
The system operates, but cooling or heating is insufficient.	<ul style="list-style-type: none"> <li>▪ Check the airflow rate setting. Refer to "5.3.2 Airflow rate" [▶ 16].</li> <li>▪ Check the temperature setting. Refer to "5.3.1 To start/stop operation mode and to set the temperature" [▶ 15].</li> <li>▪ Check if the airflow direction setting is appropriate. Refer to "5.3.3 Airflow direction" [▶ 16].</li> <li>▪ Check if the air inlet or outlet of the outdoor or indoor unit is NOT blocked by obstacles. Remove any obstacles and make sure the air can flow freely.</li> </ul>
The system operates, but cooling or heating is insufficient (air is NOT blown from the unit).	<ul style="list-style-type: none"> <li>▪ The air conditioner may be warming up for heating operation. Wait for 1 to 4 minutes.</li> <li>▪ The unit may be in defrost operation.</li> </ul>
The system operates, but cooling or heating is insufficient (air is blown from the unit).	<ul style="list-style-type: none"> <li>▪ Check if the air filters are clogged. Clean the air filters. See "7 Maintenance and service" [▶ 23].</li> <li>▪ Check for open doors or windows. Close doors and windows to prevent wind from coming in.</li> <li>▪ Check if the unit operates in Econo operation. Refer to "5.3.6 Econo operation" [▶ 19].</li> <li>▪ Check if there is any furniture directly under or next to the indoor unit. Move the furniture.</li> </ul>
An abnormal function happens during operation.	The air conditioner may malfunction because of lightning or radio waves. Turn the breaker OFF and back ON.
The unit does NOT receive signals from the user interface.	<ul style="list-style-type: none"> <li>▪ Check the batteries of the user interface.</li> <li>▪ Make sure that the transmitter is NOT exposed to direct sunlight.</li> <li>▪ Check if there are any electronic starter type fluorescent lamps in the room. Contact your dealer.</li> </ul>
The user interface display is blank.	Replace the batteries of the user interface.
An error code is displayed on the user interface.	Consult your local dealer. Refer to "8.2 Solving problems based on error codes" [▶ 30] for a detailed list of error codes.
Other electric appliances start to operate.	If the user interface signals operate other electric appliances, move the other appliances away, and contact your dealer.

If after checking all above items, it is impossible to fix the problem yourself, contact your installer and state the symptoms, the complete model name of the unit (with manufacturing number if possible) and the installation date (possibly listed on the warranty card).

## 8.1 Symptoms that are NOT system malfunctions

The following symptoms are NOT system malfunctions:

### 8.1.1 Symptom: A sound like water flowing is heard

- This sound is caused by the refrigerant flowing in the unit.
- This sound may be generated when water is flowing away from the unit during cooling or drying operation.

### 8.1.2 Symptom: A blowing sound is heard

This sound is generated when the direction of the refrigerant flow is changed (e.g. when switching from cooling to heating).

### 8.1.3 Symptom: A ticking sound is heard

This sound is generated when the unit slightly expands or contracts with changes in temperature.

### 8.1.4 Symptom: A whistling sound is heard

This sound is generated by the refrigerant flowing during defrost operation.

### 8.1.5 Symptom: A clicking sound during operation or idle time is heard

This sound is generated when the refrigerant control valves or electrical parts operate.

### 8.1.6 Symptom: A clapping sound is heard

This sound is generated when an external device sucks air out of the room (e.g. exhaust fan, extractor hood) while the doors and windows in the room are closed. Open the doors or windows, or turn off the device.

### 8.1.7 Symptom: The units can give off odours

The unit can absorb the smell of rooms, furniture, cigarettes, etc., and then emit it again.

### 8.1.8 Symptom: The outdoor fan rotates while the air conditioner is not in operation

- **After operation has stopped.** The outdoor fan continues to rotate for another 30 seconds for system protection.
- **While the air conditioner is not in operation.** When the outdoor temperature is very high, the outdoor fan starts to rotate for system protection.

## 8.2 Solving problems based on error codes

### Fault diagnosis by user interface

If the unit runs into a problem, you can identify the fault by checking the error code by the user interface. It is important to understand the problem and take measures before resetting the error code. This should be done by a licensed installer or your local dealer.



#### INFORMATION

See the service manual for:

- The complete list of error codes
- A more detailed troubleshooting guideline for each error

### To check the error code by the user interface

- 1 Aim the user interface at the unit and press **CANCEL** for about 5 seconds.

**Result:** **00** blinks in the temperature setting display section.

- 2 Aim the user interface at the unit and press **CANCEL** repeatedly until a continuous beep is heard.

**Result:** The code is now displayed on the display.



#### INFORMATION

- A short beep and 2 consecutive beeps indicate non-corresponding codes.
- To cancel the code display, hold **CANCEL** for 5 seconds. The code will also disappear from the display if the button is NOT pressed within 1 minute.

### System

Error code	Description
00	Normal
U0	Refrigerant shortage
U2	Overvoltage detection
U4	Signal transmission error (between indoor and outdoor unit)
UR	Indoor/outdoor unit combination fault

### Indoor unit

Error code	Description
R1	Indoor unit PCB abnormality
R5	Freeze-up protection or high-pressure control
R6	Fan motor (DC motor) abnormality
E9	Room temperature thermistor abnormality

### Outdoor unit

Error code	Description
ER	4-way valve abnormality
E1	Outdoor unit PCB abnormality
E5	Overload activation (compressor overload)

Error code	Description
E6	Compressor lock
E7	DC fan lock
E8	Input power overcurrent
F3	Discharge pipe temperature control
F6	High-pressure control (in cooling mode)
H0	Compressor system sensor abnormality
H6	Position sensor abnormality
H8	DC voltage / current sensor abnormality
H9	Outdoor temperature thermistor abnormality
J3	Discharge pipe thermistor abnormality
J6	Outdoor heat exchanger thermistor abnormality
L3	Electrical parts heat error
L4	Radiation fin temperature rise
L5	Inverter instantaneous overcurrent (DC)
P4	Radiation fin thermistor abnormality
F8	Compressor internal temperature error

## 9 Disposal



### NOTICE

Do NOT try to dismantle the system yourself: dismantling of the system, treatment of the refrigerant, oil and other parts **MUST** comply with applicable legislation. Units **MUST** be treated at a specialised treatment facility for reuse, recycling and recovery.



# 10 Glossary

**DHW = Domestic hot water**

Hot water used, in any type of building, for domestic purposes.

**LWT = Leaving water temperature**

Water temperature at the water outlet of the unit.

**Dealer**

Sales distributor for the product.

**Authorised installer**

Technical skilled person who is qualified to install the product.

**User**

Person who is owner of the product and/or operates the product.

**Applicable legislation**

All international, European, national and local directives, laws, regulations and/or codes that are relevant and applicable for a certain product or domain.

**Service company**

Qualified company which can perform or coordinate the required service to the product.

**Installation manual**

Instruction manual specified for a certain product or application, explaining how to install, configure and maintain it.

**Operation manual**

Instruction manual specified for a certain product or application, explaining how to operate it.

**Accessories**

Labels, manuals, information sheets and equipment that are delivered with the product and that need to be installed according to the instructions in the accompanying documentation.

**Optional equipment**

Equipment made or approved by Daikin that can be combined with the product according to the instructions in the accompanying documentation.

**Field supply**

Equipment NOT made by Daikin that can be combined with the product according to the instructions in the accompanying documentation.

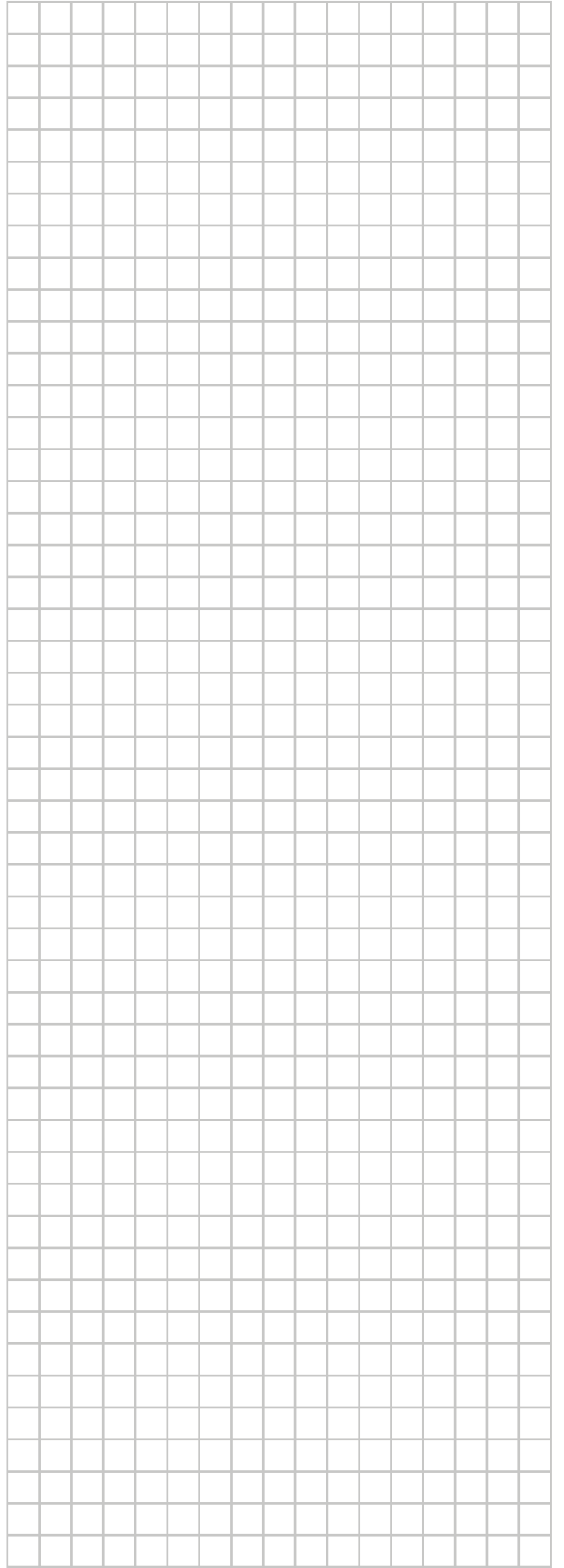

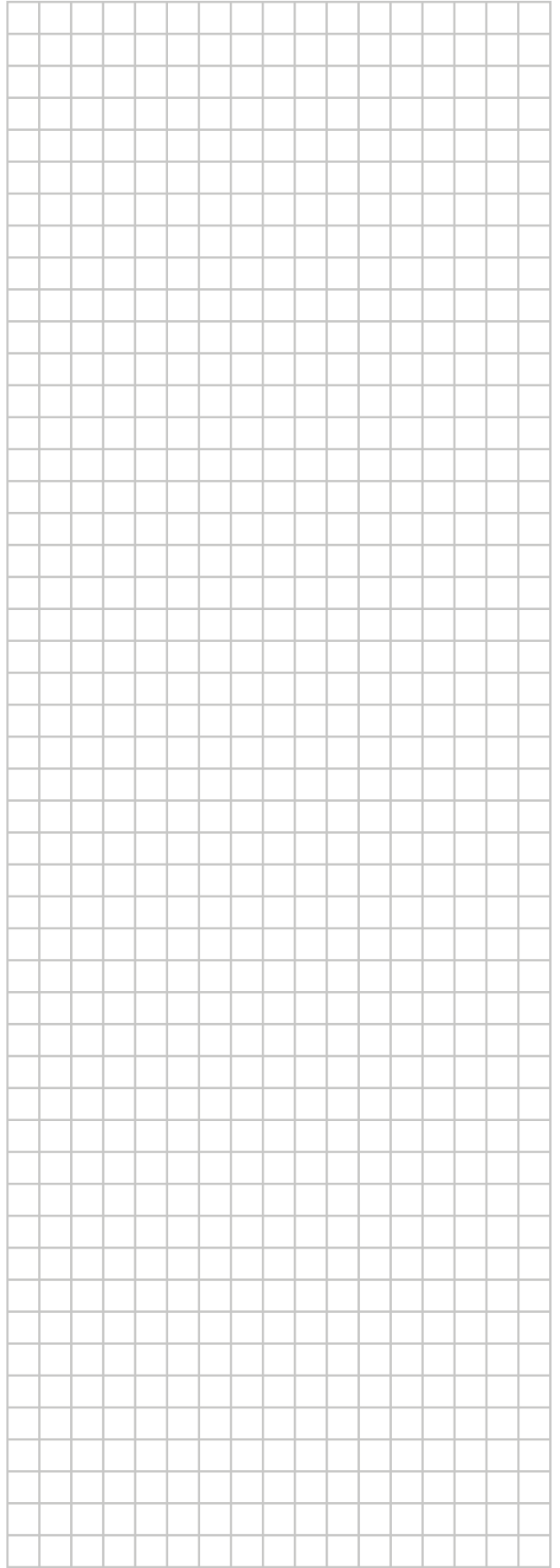

ERC

**DAIKIN ISITMA VE SOĞUTMA SİSTEMLERİ SAN.TİC. A.Ş.**

Gülsuyu Mahallesi, Fevzi Çakmak Caddesi, Burçak Sokak, No:20, 34848 Maltepe  
İSTANBUL / TÜRKİYE  
Tel: 0216 453 27 00  
Faks: 0216 671 06 00  
Çağrı Merkezi: 444 999 0  
Web: www.daikin.com.tr

**DAIKIN EUROPE N.V.**

Zandvoordestraat 300, B-8400 Oostende, Belgium

4D520466-8D 2021.06

Copyright 2021 Daikin