

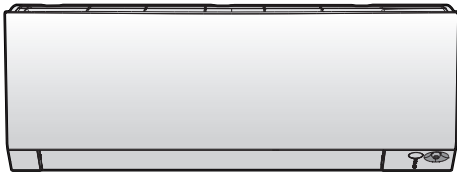

Installer reference guide  
Daikin room air conditioner



CTXM15R2V1B  
CTXM15R5V1B

FTXM20R2V1B  
FTXM20R5V1B  
FTXM25R2V1B  
FTXM25R5V1B  
FTXM35R2V1B  
FTXM35R5V1B  
FTXM42R2V1B  
FTXM42R5V1B  
FTXM50R2V1B  
FTXM60R2V1B  
FTXM71R2V1B

ATXM20R2V1B  
ATXM20R5V1B  
ATXM25R2V1B  
ATXM25R5V1B  
ATXM35R2V1B  
ATXM35R5V1B  
ATXM50R2V1B

# Table of contents

<b>1</b>	<b>About the documentation</b>	<b>4</b>
1.1	About this document .....	4
1.2	Meaning of warnings and symbols .....	5
<b>2</b>	<b>General safety precautions</b>	<b>7</b>
2.1	For the installer .....	7
2.1.1	General .....	7
2.1.2	Installation site .....	8
2.1.3	Refrigerant — in case of R410A or R32 .....	11
2.1.4	Electrical .....	12
<b>3</b>	<b>Specific installer safety instructions</b>	<b>15</b>
<b>4</b>	<b>About the box</b>	<b>17</b>
4.1	Indoor unit .....	17
4.1.1	To unpack the indoor unit .....	17
4.1.2	To remove the accessories from the indoor unit .....	17
<b>5</b>	<b>About the unit</b>	<b>19</b>
5.1	System layout .....	19
5.2	Operation range .....	19
5.3	About the wireless LAN .....	20
5.3.1	Precautions when using the wireless LAN .....	20
5.3.2	Basic parameters .....	21
5.3.3	Setting the wireless LAN .....	21
<b>6</b>	<b>Unit installation</b>	<b>22</b>
6.1	Preparing the installation site .....	22
6.1.1	Installation site requirements of the indoor unit .....	22
6.2	Opening the unit .....	23
6.2.1	To remove the front panel .....	23
6.2.2	To open the service cover .....	24
6.2.3	To remove the front grille .....	24
6.3	Mounting the indoor unit .....	25
6.3.1	To install the mounting plate .....	25
6.3.2	To drill a wall hole .....	26
6.3.3	To remove the pipe port cover .....	27
6.4	Connecting the drain piping .....	27
6.4.1	General guidelines .....	27
6.4.2	To connect the piping on right side, right-back, or right-bottom .....	29
6.4.3	To connect the piping on left side, left-back, or left-bottom .....	29
6.4.4	To check for water leaks .....	30
<b>7</b>	<b>Piping installation</b>	<b>31</b>
7.1	Preparing refrigerant piping .....	31
7.1.1	Refrigerant piping requirements .....	31
7.1.2	Refrigerant piping insulation .....	32
7.2	Connecting the refrigerant piping .....	32
7.2.1	About connecting the refrigerant piping .....	32
7.2.2	Precautions when connecting the refrigerant piping .....	33
7.2.3	Guidelines when connecting the refrigerant piping .....	34
7.2.4	Pipe bending guidelines .....	34
7.2.5	To flare the pipe end .....	34
7.2.6	To connect the refrigerant piping to the indoor unit .....	35
<b>8</b>	<b>Electrical installation</b>	<b>37</b>
8.1	About connecting the electrical wiring .....	37
8.1.1	Precautions when connecting the electrical wiring .....	37
8.1.2	Guidelines when connecting the electrical wiring .....	38
8.1.3	Specifications of standard wiring components .....	39
8.2	To connect the electrical wiring to the indoor unit .....	39
<b>9</b>	<b>Finishing the indoor unit installation</b>	<b>42</b>
9.1	To insulate the drain piping, refrigerant piping and interconnection cable .....	42
9.2	To pass the pipes through the wall hole .....	42
9.3	To fix the unit on the mounting plate .....	43
9.4	Closing the unit .....	43

9.4.1	To re-install the front grille .....	43
9.4.2	To close the service cover .....	44
9.4.3	To re-install the front panel .....	44
<b>10</b>	<b>Configuration</b>	<b>45</b>
10.1	To set a different channel of the indoor unit infrared signal receiver .....	45
<b>11</b>	<b>Commissioning</b>	<b>47</b>
11.1	Overview: Commissioning .....	47
11.2	Checklist before commissioning .....	47
11.3	To perform a test run.....	48
11.3.1	To perform a test run using the wireless remote control .....	48
<b>12</b>	<b>Hand-over to the user</b>	<b>49</b>
<b>13</b>	<b>Disposal</b>	<b>50</b>
<b>14</b>	<b>Technical data</b>	<b>51</b>
14.1	Wiring diagram.....	51
14.1.1	Unified wiring diagram legend .....	51
<b>15</b>	<b>Glossary</b>	<b>54</b>

# 1 About the documentation

## 1.1 About this document



### WARNING

Make sure installation, servicing, maintenance, repair and applied materials follow the instructions from Daikin and, in addition, comply with applicable legislation and are performed by qualified persons only. In Europe and areas where IEC standards apply, EN/IEC 60335-2-40 is the applicable standard.



### INFORMATION

Make sure that the user has the printed documentation and ask him/her to keep it for future reference.

### Target audience

Authorised installers



### INFORMATION

This appliance is intended to be used by expert or trained users in shops, in light industry, and on farms, or for commercial and household use by lay persons.

### Documentation set

This document is part of a documentation set. The complete set consists of:

- **General safety precautions:**
  - Safety instructions that you **MUST** read before installing
  - Format: Paper (in the box of the indoor unit)
- **Indoor unit installation manual:**
  - Installation instructions
  - Format: Paper (in the box of the indoor unit)
- **Installer reference guide:**
  - Preparation of the installation, good practices, reference data,...
  - Format: Digital files on <https://www.daikin.eu>. Use the search function 🔍 to find your model.

Latest revisions of the supplied documentation may be available on the regional Daikin website or via your dealer.

Scan the QR code below to find the full documentation set and more information about your product on Daikin website.



ATXM-R











C/FTXM-R

The original documentation is written in English. All other languages are translations.



### Technical engineering data

- A **subset** of the latest technical data is available on the regional Daikin website (publicly accessible).
- The **full set** of latest technical data is available on the Daikin Business Portal (authentication required).

## 1.2 Meaning of warnings and symbols



	<b>DANGER</b> Indicates a situation that results in death or serious injury.
	<b>DANGER: RISK OF ELECTROCUTION</b> Indicates a situation that could result in electrocution.
	<b>DANGER: RISK OF BURNING/SCALDING</b> Indicates a situation that could result in burning/scalding because of extreme hot or cold temperatures.
	<b>DANGER: RISK OF EXPLOSION</b> Indicates a situation that could result in explosion.
	<b>WARNING</b> Indicates a situation that could result in death or serious injury.
	<b>WARNING: FLAMMABLE MATERIAL</b>
	<b>CAUTION</b> Indicates a situation that could result in minor or moderate injury.
	<b>NOTICE</b> Indicates a situation that could result in equipment or property damage.
	<b>INFORMATION</b> Indicates useful tips or additional information.

Symbols used on the unit:

Symbol	Explanation
	Before installation, read the installation and operation manual, and the wiring instruction sheet.
	Before performing maintenance and service tasks, read the service manual.
	For more information, see the installer and user reference guide.

Symbol	Explanation
	The unit contains rotating parts. Be careful when servicing or inspecting the unit.

Symbols used in the documentation:

Symbol	Explanation
	Indicates a figure title or a reference to it. <b>Example:</b> "▲ 1-3 Figure title" means "Figure 3 in chapter 1".
	Indicates a table title or a reference to it. <b>Example:</b> "■ 1-3 Table title" means "Table 3 in chapter 1".

## 2 General safety precautions

### 2.1 For the installer

#### 2.1.1 General



#### **DANGER: RISK OF BURNING/SCALDING**

- Do NOT touch the refrigerant piping, water piping or internal parts during and immediately after operation. It could be too hot or too cold. Give it time to return to normal temperature. If you MUST touch it, wear protective gloves.
- Do NOT touch any accidental leaking refrigerant.



#### **WARNING**

Improper installation or attachment of equipment or accessories could result in electrical shock, short-circuit, leaks, fire or other damage to the equipment. ONLY use accessories, optional equipment and spare parts made or approved by Daikin.



#### **WARNING**

Make sure installation, testing and applied materials comply with applicable legislation (on top of the instructions described in the Daikin documentation).



#### **WARNING**

Tear apart and throw away plastic packaging bags so that nobody, especially children, can play with them. Possible risk: suffocation.



#### **WARNING**

Provide adequate measures to prevent that the unit can be used as a shelter by small animals. Small animals that make contact with electrical parts can cause malfunctions, smoke or fire.



#### **CAUTION**

Wear adequate personal protective equipment (protective gloves, safety glasses,...) when installing, maintaining or servicing the system.



#### **CAUTION**

Do NOT touch the air inlet or aluminium fins of the unit.



#### **CAUTION**

- Do NOT place any objects or equipment on top of the unit.
- Do NOT sit, climb or stand on the unit.

If you are NOT sure how to install or operate the unit, contact your dealer.

In accordance with the applicable legislation, it might be necessary to provide a logbook with the product containing at least: information on maintenance, repair work, results of tests, stand-by periods,...

Also, at least, following information MUST be provided at an accessible place at the product:

- Instructions for shutting down the system in case of an emergency
  - Name and address of fire department, police and hospital
  - Name, address and day and night telephone numbers for obtaining service
- In Europe, EN378 provides the necessary guidance for this logbook.

### 2.1.2 Installation site

- Provide sufficient space around the unit for servicing and air circulation.
- Make sure the installation site withstands the weight and vibration of the unit.
- Make sure the area is well ventilated. Do NOT block any ventilation openings.
- Make sure the unit is level.

Do NOT install the unit in the following places:

- In potentially explosive atmospheres.
- In places where there is machinery that emits electromagnetic waves. Electromagnetic waves may disturb the control system, and cause malfunction of the equipment.
- In places where there is a risk of fire due to the leakage of flammable gases (example: thinner or gasoline), carbon fibre, ignitable dust.
- In places where corrosive gas (example: sulphurous acid gas) is produced. Corrosion of copper pipes or soldered parts may cause the refrigerant to leak.
- In bathrooms.

### Instructions for equipment using R32 refrigerant



#### **WARNING: MILDLY FLAMMABLE MATERIAL**

The refrigerant inside this unit is mildly flammable.



#### **WARNING**

- Do NOT pierce or burn refrigerant cycle parts.
- Do NOT use cleaning materials or means to accelerate the defrosting process other than those recommended by the manufacturer.
- Be aware that the refrigerant inside the system is odourless.



#### **WARNING**

The appliance shall be stored so as to prevent mechanical damage and in a well-ventilated room without continuously operating ignition sources (example: open flames, an operating gas appliance or an operating electric heater) and have a room size as specified below.



#### **WARNING**

Make sure installation, servicing, maintenance and repair comply with instructions from Daikin and with applicable legislation and are executed ONLY by authorised persons.



#### **CAUTION**

Do NOT use potential sources of ignition in searching for or detection of refrigerant leaks.



**NOTICE**

- Take precautions to avoid excessive vibration or pulsation to refrigeration piping.
- Protect the protection devices, piping and fittings as much as possible against adverse environmental effects.
- Provide space for expansion and contraction of long runs of piping.
- Design and install piping in refrigerating systems such as to minimise the likelihood of hydraulic shock damaging the system.
- Mount the indoor equipment and pipes securely and protect them to avoid accidental rupture of equipment or pipes in case of events such as moving furniture or reconstruction activities.

**NOTICE**

- Do NOT re-use joints and copper gaskets which have been used already.
- Joints made in installation between parts of refrigerant system shall be accessible for maintenance purposes.

**WARNING**

If one or more rooms are connected to the unit using a duct system, make sure:

- there are no operating ignition sources (example: open flames, an operating gas appliance or an operating electric heater) in case the floor area is less than the minimum floor area A (m<sup>2</sup>).
- no auxiliary devices, which may be a potential ignition source, are installed in the duct work (example: hot surfaces with a temperature exceeding 700°C and electric switching device);
- only auxiliary devices approved by the manufacturer are used in the duct work;
- air inlet AND outlet are connected directly to the same room by ducting. Do NOT use spaces such as a false ceiling as a duct for the air inlet or outlet.

**Installation space requirements****WARNING**

If appliances contain R32 refrigerant, the floor area of the room in which the appliances are installed, operated and stored **MUST** be larger than the minimum floor area defined in table below A (m<sup>2</sup>). This applies to:

- Indoor units **without** a refrigerant leakage sensor; in case of indoor units **with** refrigerant leakage sensor, consult the installation manual
- Outdoor units installed or stored indoors (e.g. winter garden, garage, machinery room)

**NOTICE**

- Protect pipework from physical damage.
- Keep the pipework installation to a minimum.

**To determine the minimum floor area**

- 1 Determine the total refrigerant charge in the system (= factory refrigerant charge ❶ + ❷ additional refrigerant amount charged).

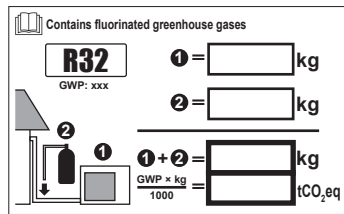

2 Determine which graph or table to use.

- For indoor units: Is the unit ceiling-mounted, wall-mounted or floor-standing?
- For outdoor units installed or stored indoors, this depends on the installation height:

If the installation height is...	Then use the graph or table for...
<1.8 m	Floor-standing units
1.8 ≤ x < 2.2 m	Wall-mounted units
≥ 2.2 m	Ceiling-mounted units

3 Use the graph or table to determine the minimum floor area.

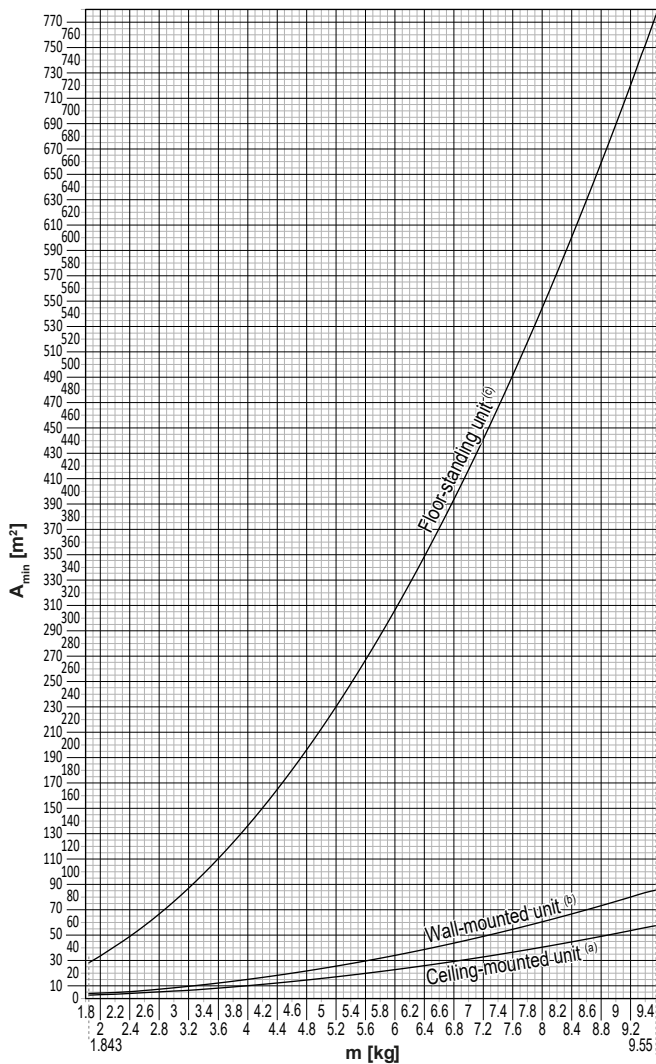

Ceiling-mounted unit <sup>(a)</sup>		Wall-mounted unit <sup>(b)</sup>		Floor-standing unit <sup>(c)</sup>	
m (kg)	A <sub>min</sub> (m <sup>2</sup> )	m (kg)	A <sub>min</sub> (m <sup>2</sup> )	m (kg)	A <sub>min</sub> (m <sup>2</sup> )
≤1.842	—	≤1.842	—	≤1.842	—
1.843	3.64	1.843	4.45	1.843	28.9
2.0	3.95	2.0	4.83	2.0	34.0
2.2	4.34	2.2	5.31	2.2	41.2
2.4	4.74	2.4	5.79	2.4	49.0
2.6	5.13	2.6	6.39	2.6	57.5
2.8	5.53	2.8	7.41	2.8	66.7
3.0	5.92	3.0	8.51	3.0	76.6
3.2	6.48	3.2	9.68	3.2	87.2
3.4	7.32	3.4	10.9	3.4	98.4
3.6	8.20	3.6	12.3	3.6	110
3.8	9.14	3.8	13.7	3.8	123
4.0	10.1	4.0	15.1	4.0	136
4.2	11.2	4.2	16.7	4.2	150
4.4	12.3	4.4	18.3	4.4	165
4.6	13.4	4.6	20.0	4.6	180
4.8	14.6	4.8	21.8	4.8	196
5.0	15.8	5.0	23.6	5.0	213
5.2	17.1	5.2	25.6	5.2	230
5.4	18.5	5.4	27.6	5.4	248
5.6	19.9	5.6	29.7	5.6	267
5.8	21.3	5.8	31.8	5.8	286
6.0	22.8	6.0	34.0	6.0	306
6.2	24.3	6.2	36.4	6.2	327
6.4	25.9	6.4	38.7	6.4	349
6.6	27.6	6.6	41.2	6.6	371
6.8	29.3	6.8	43.7	6.8	394
7.0	31.0	7.0	46.3	7.0	417
7.2	32.8	7.2	49.0	7.2	441
7.4	34.7	7.4	51.8	7.4	466
7.6	36.6	7.6	54.6	7.6	492
7.8	38.5	7.8	57.5	7.8	518
8	40.5	8	60.5	8	545
8.2	42.6	8.2	63.6	8.2	572
8.4	44.7	8.4	66.7	8.4	601
8.6	46.8	8.6	69.9	8.6	629
8.8	49.0	8.8	73.2	8.8	659
9	51.3	9	76.6	9	689
9.2	53.6	9.2	80.0	9.2	720
9.4	55.9	9.4	83.6	9.4	752
9.55	57.7	9.55	86.2	9.55	776

- m** Total refrigerant charge in the system
- A<sub>min</sub>** Minimum floor area
- (a)** Ceiling-mounted unit (= Ceiling-mounted unit)
- (b)** Wall-mounted unit (= Wall-mounted unit)
- (c)** Floor-standing unit (= Floor-standing unit)

## 2.1.3 Refrigerant — in case of R410A or R32

If applicable. See the installation manual or installer reference guide of your application for more information.

**DANGER: RISK OF EXPLOSION**

**Pump down – Refrigerant leakage.** If you want to pump down the system, and there is a leak in the refrigerant circuit:

- Do NOT use the unit's automatic pump down function, with which you can collect all refrigerant from the system into the outdoor unit. **Possible consequence:** Self-combustion and explosion of the compressor because of air going into the operating compressor.
- Use a separate recovery system so that the unit's compressor does NOT have to operate.

**WARNING**

During tests, NEVER pressurise the product with a pressure higher than the maximum allowable pressure (as indicated on the nameplate of the unit).

**WARNING**

Take sufficient precautions in case of refrigerant leakage. If refrigerant gas leaks, ventilate the area immediately. Possible risks:

- Excessive refrigerant concentrations in a closed room can lead to oxygen deficiency.
- Toxic gas might be produced if refrigerant gas comes into contact with fire.

**WARNING**

ALWAYS recover the refrigerant. Do NOT release them directly into the environment. Use a vacuum pump to evacuate the installation.

**WARNING**

Make sure there is no oxygen in the system. Refrigerant may ONLY be charged after performing the leak test and the vacuum drying.

**Possible consequence:** Self-combustion and explosion of the compressor because of oxygen going into the operating compressor.

**NOTICE**

- To avoid compressor breakdown, do NOT charge more than the specified amount of refrigerant.
- When the refrigerant system is to be opened, refrigerant MUST be treated according to the applicable legislation.

**NOTICE**

Make sure refrigerant piping installation complies with applicable legislation. In Europe, EN378 is the applicable standard.

**NOTICE**



Make sure the field piping and connections are NOT subjected to stress.



**NOTICE**

After all the piping has been connected, make sure there is no gas leak. Use nitrogen to perform a gas leak detection.

- In case recharge is required, see the nameplate of the unit. It states the type of refrigerant and necessary amount.
- The unit is factory charged with refrigerant and depending on pipe sizes and pipe lengths some systems require additional charging of refrigerant.
- **ONLY** use tools exclusively for the refrigerant type used in the system, this to ensure pressure resistance and prevent foreign materials from entering into the system.
- Charge the liquid refrigerant as follows:

If	Then
A siphon tube is present (i.e., the cylinder is marked with "Liquid filling siphon attached")	Charge with the cylinder upright. 
A siphon tube is NOT present	Charge with the cylinder upside down. 

- Open refrigerant cylinders slowly.
- Charge the refrigerant in liquid form. Adding it in gas form may prevent normal operation.



**CAUTION**

When the refrigerant charging procedure is done or when pausing, close the valve of the refrigerant tank immediately. If the valve is NOT closed immediately, remaining pressure might charge additional refrigerant. **Possible consequence:** Incorrect refrigerant amount.

2.1.4 Electrical



**DANGER: RISK OF ELECTROCUTION**

- Turn OFF all power supply before removing the switch box cover, connecting electrical wiring or touching electrical parts.
- Disconnect the power supply for more than 10 minutes, and measure the voltage at the terminals of main circuit capacitors or electrical components before servicing. The voltage **MUST** be less than 50 V DC before you can touch electrical components. For the location of the terminals, see the wiring diagram.
- Do NOT touch electrical components with wet hands.
- Do NOT leave the unit unattended when the service cover is removed.



**WARNING**

If NOT factory installed, a main switch or other means for disconnection, having a contact separation in all poles providing full disconnection under overvoltage category III condition, **MUST** be installed in the fixed wiring.

**WARNING**

- ONLY use copper wires.
- Make sure the field wiring complies with the applicable legislation.
- All field wiring MUST be performed in accordance with the wiring diagram supplied with the product.
- NEVER squeeze bundled cables and make sure they do NOT come in contact with the piping and sharp edges. Make sure no external pressure is applied to the terminal connections.
- Make sure to install earth wiring. Do NOT earth the unit to a utility pipe, surge absorber, or telephone earth. Incomplete earth may cause electrical shock.
- Make sure to use a dedicated power circuit. NEVER use a power supply shared by another appliance.
- Make sure to install the required fuses or circuit breakers.
- Make sure to install an earth leakage protector. Failure to do so may cause electrical shock or fire.
- When installing the earth leakage protector, make sure it is compatible with the inverter (resistant to high frequency electric noise) to avoid unnecessary opening of the earth leakage protector.

**WARNING**

- After finishing the electrical work, confirm that each electrical component and terminal inside the electrical components box is connected securely.
- Make sure all covers are closed before starting up the unit.

**CAUTION**

- When connecting the power supply: connect the earth cable first, before making the current-carrying connections.
- When disconnecting the power supply: disconnect the current-carrying cables first, before separating the earth connection.
- The length of the conductors between the power supply stress relief and the terminal block itself MUST be as such that the current-carrying wires are tightened before the earth wire is in case the power supply is pulled loose from the stress relief.

**NOTICE**

Precautions when laying power wiring:



- Do NOT connect wiring of different thicknesses to the power terminal block (slack in the power wiring may cause abnormal heat).
- When connecting wiring which is the same thickness, do as shown in the figure above.
- For wiring, use the designated power wire and connect firmly, then secure to prevent outside pressure being exerted on the terminal board.
- Use an appropriate screwdriver for tightening the terminal screws. A screwdriver with a small head will damage the head and make proper tightening impossible.
- Over-tightening the terminal screws may break them.

Install power cables at least 1 meter away from televisions or radios to prevent interference. Depending on the radio waves, a distance of 1 meter may NOT be sufficient.

**NOTICE**

ONLY applicable if the power supply is three-phase, and the compressor has an ON/OFF starting method.

If there exists the possibility of reversed phase after a momentary black out and the power goes ON and OFF while the product is operating, attach a reversed phase protection circuit locally. Running the product in reversed phase can break the compressor and other parts.

## 3 Specific installer safety instructions

Always observe the following safety instructions and regulations.

### Unit installation (see "6 Unit installation" [▶ 22])



#### WARNING

Installation shall be done by an installer, the choice of materials and installation shall comply with the applicable legislation. In Europe, EN378 is the applicable standard.



#### WARNING

The appliance shall be stored so as to prevent mechanical damage and in a well-ventilated room without continuously operating ignition sources (e.g. open flames, an operating gas appliance, or an operating electric heater). The room size shall be as specified in the General safety precaution.



#### CAUTION

For walls containing a metal frame or a metal board, use a wall embedded pipe and wall cover in the feed-through hole to prevent possible heat, electrical shock, or fire.

### Piping installation (see "7 Piping installation" [▶ 31])



#### CAUTION

Piping and joints of a split system shall be made with permanent joints when inside an occupied space except joints directly connecting the piping to the indoor units.



#### DANGER: RISK OF BURNING/SCALDING



#### CAUTION

- Incomplete flaring may cause refrigerant gas leakage.
- Do NOT re-use flares. Use new flares to prevent refrigerant gas leakage.
- Use flare nuts that are included with the unit. Using different flare nuts may cause refrigerant gas leakage.

### Electrical installation (see "8 Electrical installation" [▶ 37])



#### DANGER: RISK OF ELECTROCUTION



#### WARNING

ALWAYS use multicore cable for power supply cables.



#### WARNING

- All wiring MUST be performed by an authorised electrician and MUST comply with the applicable legislation.
- Make electrical connections to the fixed wiring.
- All components procured on-site and all electrical construction MUST comply with the applicable legislation.



#### WARNING

- If the power supply has a missing or wrong N-phase, equipment might break down.
- Establish proper earthing. Do NOT earth the unit to a utility pipe, surge absorber, or telephone earth. Incomplete earthing may cause electrical shock.
- Install the required fuses or circuit breakers.
- Secure the electrical wiring with cable ties so that the cables do NOT come in contact with sharp edges or piping, particularly on the high-pressure side.
- Do NOT use taped wires, stranded conductor wires, extension cords, or connections from a star system. They can cause overheating, electrical shock or fire.
- Do NOT install a phase advancing capacitor, because this unit is equipped with an inverter. A phase advancing capacitor will reduce performance and may cause accidents.



#### WARNING

Use an all-pole disconnection type breaker with at least 3 mm between the contact point gaps that provides full disconnection under overvoltage category III.



#### WARNING

If the supply cord is damaged, it MUST be replaced by the manufacturer, its service agent or similarly qualified persons in order to avoid a hazard.



#### WARNING

Do NOT connect the power supply to the indoor unit. This could result in electrical shock or fire.



#### WARNING

- Do NOT use locally purchased electrical parts inside the product.
- Do NOT branch the power supply for the drain pump, etc. from the terminal block. This could result in electrical shock or fire.



#### WARNING

Keep the interconnection wiring away from copper pipes without thermal insulation as such pipes will be very hot.



## 4 About the box

Keep the following in mind:

- At delivery, the unit **MUST** be checked for damage and completeness. Any damage or missing parts **MUST** be reported immediately to the claims agent of the carrier.
- Bring the packed unit as close as possible to its final installation position to prevent damage during transport.
- Prepare in advance the path along which you want to bring the unit to its final installation position.
- When handling the unit, take into account the following:
  - ☒ Fragile, handle the unit with care.
  - ☒ Keep the unit upright in order to avoid damage.

### 4.1 Indoor unit

#### 4.1.1 To unpack the indoor unit

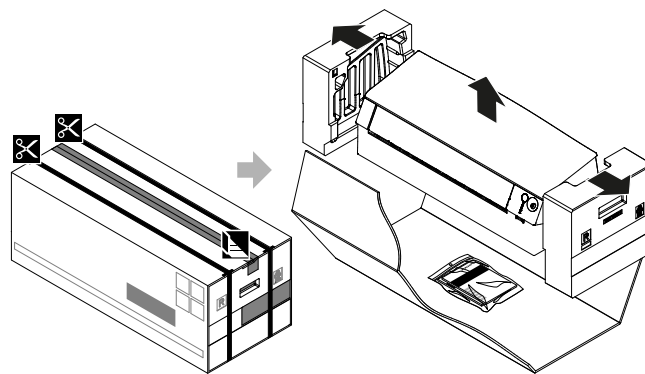

#### 4.1.2 To remove the accessories from the indoor unit

**1** Remove:

- the accessory bag located at the bottom of the package,
- the mounting plate attached to the back of the indoor unit,
- the spare SSID sticker located on the front grille.

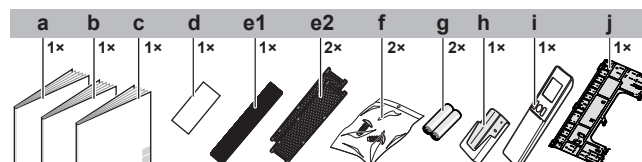

- a** Installation manual
- b** Operation manual
- c** General safety precautions
- d** Spare SSID sticker
- e1** **Class 15~42:** Silver allergen removal air purifying filter (without frame)
- e2** **Class 50~71:** Titanium apatite deodorising filter and silver allergen removal air purifying filter (with frame)
- f** Indoor unit fixing screw (M4×12L). Refer to ["9.3 To fix the unit on the mounting plate"](#) [▶ 43].
- g** Dry battery AAA.LR03 (alkaline) for wireless remote control

- h** Wireless remote control (user interface) holder
- i** Wireless remote control (user interface)
- j** Mounting plate

- **Spare SSID sticker.** Do NOT throw away the spare sticker. Keep it in a safe place in case it is needed in future (e.g. in case the front grille was replaced attach it to the new front grille).

## 5 About the unit



### WARNING: MILDLY FLAMMABLE MATERIAL

The refrigerant inside this unit is mildly flammable.

### 5.1 System layout

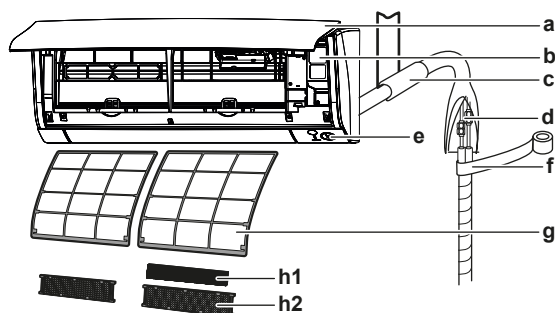

- a Front cover
- b Service cover
- c Caulk pipe hole gap with putty
- d Refrigerant piping, drain hose and interconnection cable
- e Intelligent eye sensor
- f Insulation tape
- g Air filters
- h1 **Class 15~42:** Silver allergen removal air purifying filter (without frame)
- h2 **Class 50~71:** Titanium apatite deodorising filter and silver allergen removal air purifying filter (with frame)

### 5.2 Operation range

Use the system in the following temperature and humidity ranges for safe and effective operation.

In combination with outdoor unit RZAG		
	Cooling and drying <sup>(a)(b)</sup>	Heating <sup>(a)</sup>
Outdoor temperature	-20~52°C DB	-20~24°C DB -21~18°C WB
Indoor temperature	17~38°C DB 12~28°C WB	10~27°C DB
Indoor humidity	≤80% <sup>(b)</sup>	—

<sup>(a)</sup> A safety device might stop the operation of the system if the unit runs outside its operation range.

<sup>(b)</sup> Condensation and water dripping might occur if the unit runs outside its operation range.

In combination with outdoor units: RXM71R, 2MXM, 2AMXM, 3MXM, 3AMXM, 4MXM, 5MXM		
	Cooling and drying <sup>(a)(b)</sup>	Heating <sup>(a)</sup>
Outdoor temperature	-10~46°C DB	-15~24°C DB -15~18°C WB

In combination with outdoor units: RXM71R, 2MXM, 2AMXM, 3MXM, 3AMXM, 4MXM, 5MXM		
	Cooling and drying <sup>(a)(b)</sup>	Heating <sup>(a)</sup>
Indoor temperature	18~37°C DB 14~28°C WB	10~30°C DB
Indoor humidity	≤80% <sup>(a)</sup>	—

<sup>(a)</sup> A safety device might stop the operation of the system if the unit runs outside its operation range.

<sup>(b)</sup> Condensation and water dripping might occur if the unit runs outside its operation range.

In combination with other outdoor units		
	Cooling and drying <sup>(a)(b)</sup>	Heating <sup>(a)</sup>
Outdoor temperature	-10~50°C DB	-20~24°C DB -21~18°C WB
Indoor temperature	18~37°C DB 14~28°C WB	10~30°C DB
Indoor humidity	≤80% <sup>(b)</sup>	—

<sup>(a)</sup> A safety device might stop the operation of the system if the unit runs outside its operation range.

<sup>(b)</sup> Condensation and water dripping might occur if the unit runs outside its operation range.

### 5.3 About the wireless LAN

For detailed specifications, installation instructions, setting methods, FAQ, declaration of conformity and the latest version of this manual, visit [app.daikineurope.com](http://app.daikineurope.com).



#### INFORMATION: Declaration of conformity

- Daikin Industries Czech Republic s.r.o. declares that the radio equipment type inside of this unit is in compliance with Directive 2014/53/EU and S.I. 2017/1206: Radio Equipment Regulations 2017.
- This unit is considered as combined equipment according to the definition of Directive 2014/53/EU and S.I. 2017/1206: Radio Equipment Regulations 2017.

#### 5.3.1 Precautions when using the wireless LAN

Do NOT use near:

- **Medical equipment.** E.g. persons using cardiac pacemakers or defibrillators. This product may cause electromagnetic interference.
- **Auto-control equipment.** E.g. automatic doors or fire alarm equipment. This product may cause faulty behaviour of the equipment.
- **Microwave oven.** It may affect wireless LAN communications.

### 5.3.2 Basic parameters

What	Value
Frequency range	2400 MHz~2483.5 MHz
Radio protocol	IEEE 802.11b/g/n
Radio frequency channel	1~13
Output power	13 dBm
Effective radiated power	15 dBm (11b) / 14 dBm (11g) / 14 dBm (11n)
Power supply	DC 14 V / 100 mA

### 5.3.3 Setting the wireless LAN

The customer is responsible for providing:

- Smartphone or tablet with minimum supported version of Android or iOS, specified on [app.daikineurope.com](http://app.daikineurope.com)
- Internet line and communicating device, such as modem, router, etc.
- Wireless LAN access point.
- Installed free ONECTA application.

#### To install the ONECTA app

- 1 Open:
  - Google Play for appliances using Android.
  - App Store for appliances using iOS.
- 2 Search for "ONECTA".
- 3 Follow the directions on the screen to install.

# 6 Unit installation



## WARNING

Installation shall be done by an installer, the choice of materials and installation shall comply with the applicable legislation. In Europe, EN378 is the applicable standard.

## In this chapter

6.1	Preparing the installation site .....	22
6.1.1	Installation site requirements of the indoor unit.....	22
6.2	Opening the unit.....	23
6.2.1	To remove the front panel.....	23
6.2.2	To open the service cover.....	24
6.2.3	To remove the front grille.....	24
6.3	Mounting the indoor unit.....	25
6.3.1	To install the mounting plate.....	25
6.3.2	To drill a wall hole .....	26
6.3.3	To remove the pipe port cover.....	27
6.4	Connecting the drain piping.....	27
6.4.1	General guidelines.....	27
6.4.2	To connect the piping on right side, right-back, or right-bottom.....	29
6.4.3	To connect the piping on left side, left-back, or left-bottom.....	29
6.4.4	To check for water leaks .....	30

## 6.1 Preparing the installation site

Choose an installation location with sufficient space to transport the unit in and out of the site.

Do NOT install the unit in places often used as work place. In case of construction works (e.g. grinding works) where a lot of dust is created, the unit MUST be covered.



## WARNING

The appliance shall be stored so as to prevent mechanical damage and in a well-ventilated room without continuously operating ignition sources (e.g. open flames, an operating gas appliance, or an operating electric heater). The room size shall be as specified in the General safety precaution.

### 6.1.1 Installation site requirements of the indoor unit



## INFORMATION

Also read the precautions and requirements in the "[2 General safety precautions](#)" [[▶ 7](#)].



## INFORMATION

The sound pressure level is less than 70 dBA.

- **Air flow.** Make sure nothing blocks the air flow.
- **Drainage.** Make sure condensation water can be evacuated properly.
- **Wall insulation.** When conditions in the wall exceed 30°C and a relative humidity of 80%, or when fresh air is inducted into the wall, then additional insulation is required (minimum 10 mm thickness, polyethylene foam).

- **Wall strength.** Check whether the wall or the floor is strong enough to support the weight of the unit. If there is a risk, reinforce the wall or the floor before installing the unit.

Install power cables at least 1 metre away from televisions or radios to prevent interference. Depending on the radio waves, a distance of 3 metres may NOT be sufficient.

- Choose a location where the operation noise or the hot/cold air discharged from the unit will not disturb anyone and the location is selected according to the applicable legislation.
- **Fluorescent lights.** When installing a wireless remote control (user interface) in a room with fluorescent lights, mind the following to avoid interference:
  - Install the wireless remote control (user interface) as close as possible to the indoor unit.
  - Install the indoor unit as far as possible from the fluorescent lights.

It is NOT recommended to install the unit in the following places because it may shorten the life of the unit:

- Where the voltage fluctuates a lot
- In vehicles or vessels
- Where acidic or alkaline vapour is present
- In places where a mineral oil mist, spray or vapour may be present in the atmosphere. Plastic parts may deteriorate and fall off or cause water leakage.
- In places where the unit would be in the path of direct sunlight.
- In bathrooms.
- Sound sensitive areas (e.g. near a bedroom), so that the operation noise will cause no trouble.



#### NOTICE

Do NOT place objects below the indoor and/or outdoor unit that may get wet. Otherwise condensation on the unit or refrigerant pipes, air filter dirt or drain blockage may cause dripping, and objects under the unit may get dirty or damaged.

- **Spacing.** Install the unit at least 1.8 m from the floor and keep the following requirements in mind for distances from the walls and the ceiling:

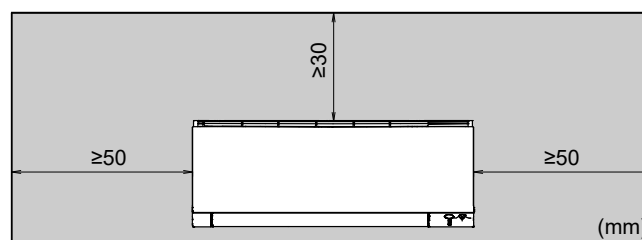

## 6.2 Opening the unit

### 6.2.1 To remove the front panel

- 1 Hold the front panel by the panel tabs on both sides and open it.

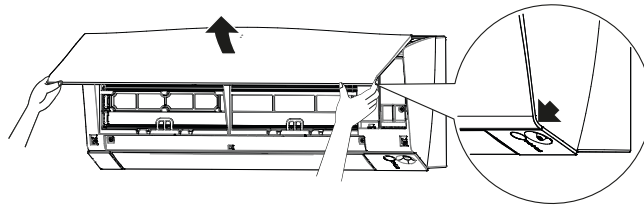

- 2 Remove the front panel by sliding it to the left or the right and pulling it toward you.

**Result:** The front panel shaft on 1 side will be disconnected.

- 3 Disconnect the front panel shaft on the other side in the same manner.

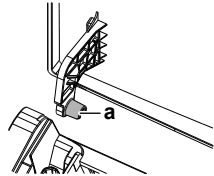

a Front panel shaft

### 6.2.2 To open the service cover

- 1 Remove 1 screw from the service cover.
- 2 Pull out the service cover horizontally away from the unit.

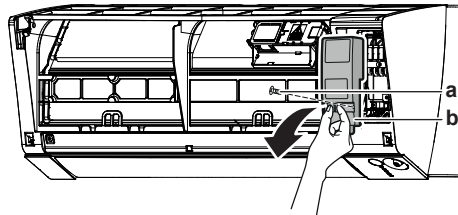

a Service cover screw  
b Service cover



#### NOTICE

When closing the service cover, make sure that the tightening torque does NOT exceed 1.4 ( $\pm 0.2$ ) N•m.

### 6.2.3 To remove the front grille



#### CAUTION

Wear adequate personal protective equipment (protective gloves, safety glasses,...) when installing, maintaining or servicing the system.

- 1 Remove the front panel to remove the air filter.
- 2 **For class 50~71** remove the flap (horizontal blade). Push the blade on its left side to the centre and unhook it. Push blade on its right side to centre to unhook it from shaft. Disconnect the 2 centre connection points.

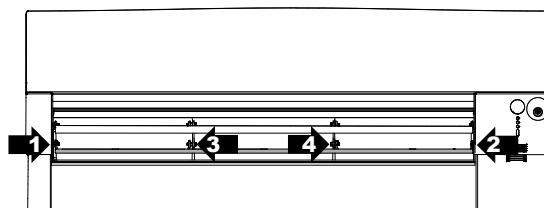



- 3 Remove 2 screws (class 15~42) or 3 screws (class 50~71) from the front grille.
- 4 Push down the 3 upper hooks marked with a symbol with 3 circles.

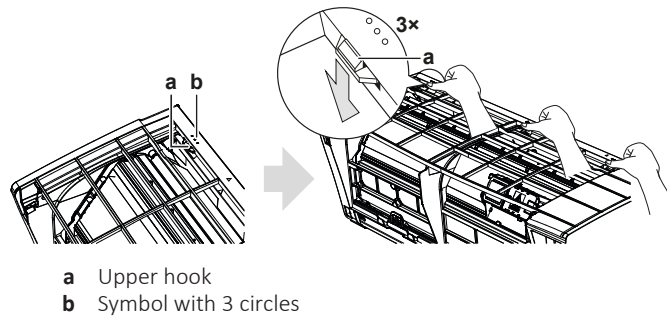

- 5 We recommend opening the flap before removing the front grille.
- 6 Place both hands under the centre of the front grille, push it up and then toward you.

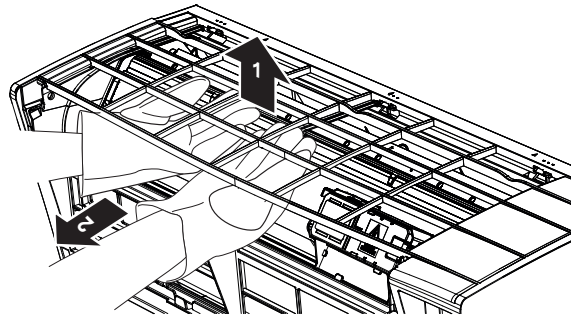

## 6.3 Mounting the indoor unit

In this chapter

6.3.1	To install the mounting plate.....	25
6.3.2	To drill a wall hole .....	26
6.3.3	To remove the pipe port cover.....	27

### 6.3.1 To install the mounting plate

- 1 Install the mounting plate temporarily.
- 2 Level the mounting plate.
- 3 Mark the centres of the drilling points on the wall using a tape measure. Position the end of tape measure at symbol ">".
- 4 Finish the installation by securing the mounting plate on the wall using M4×25L screws (field supply).

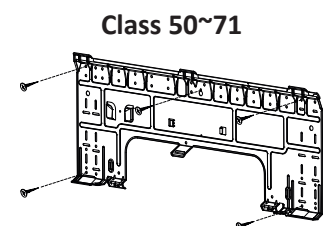
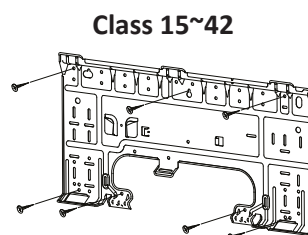

#### INFORMATION

The removed pipe port cover can be kept in the mounting plate pocket.

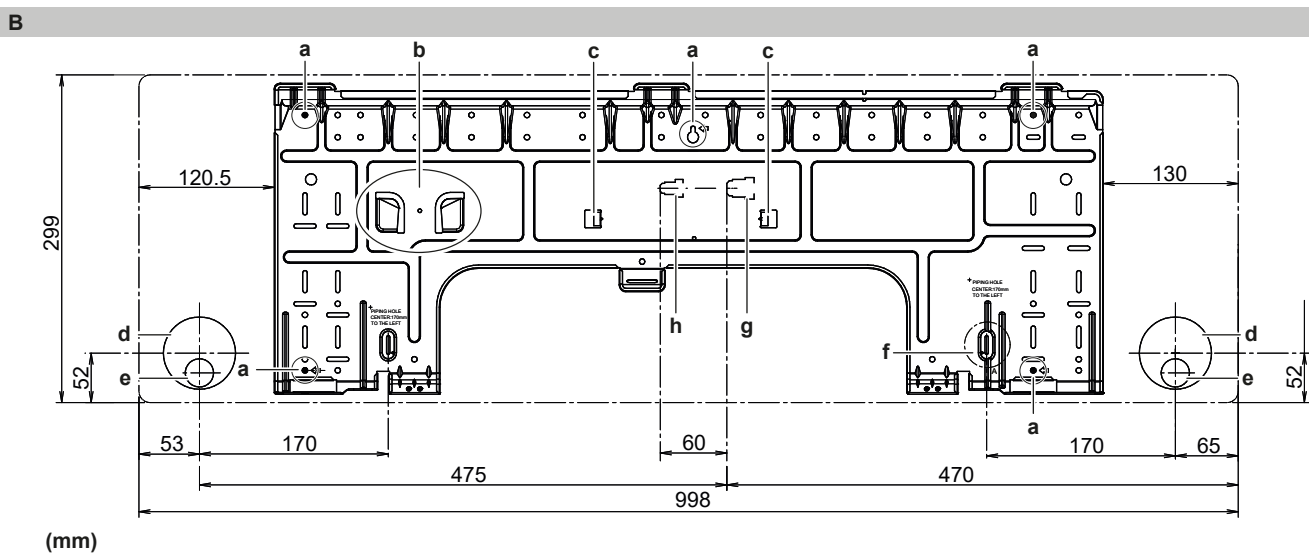
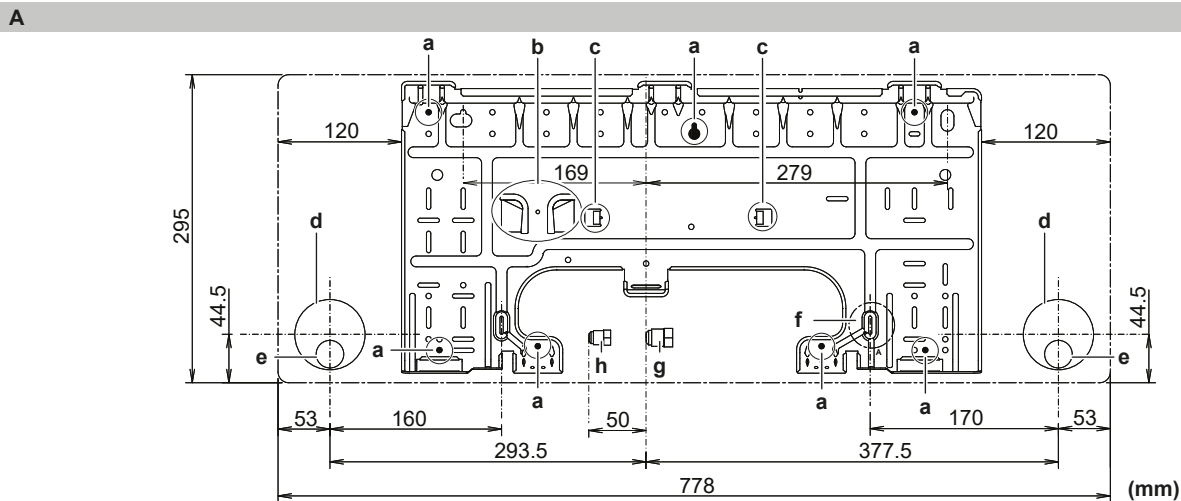

**A** For class: 15~42

**B** For class: 50~71

**a** Recommended mounting plate fixing spots

**b** Pocket for the pipe port cover

**c** Tabs for placing a spirit level

**d** Through-the-wall hole:

Class 15~42  $\varnothing$ 65 mm

Class 50~71  $\varnothing$ 80 mm

**f** Position for the tape measure at symbol ">"

**g** Gas pipe end

**h** Liquid pipe end

**e** Drain hose position

### 6.3.2 To drill a wall hole



#### CAUTION

For walls containing a metal frame or a metal board, use a wall embedded pipe and wall cover in the feed-through hole to prevent possible heat, electrical shock, or fire.



#### NOTICE

Be sure to seal the gaps around the pipes with sealing material (field supply), in order to prevent water leakage.

- 1 Bore a 65 mm (class 15~42) or 80 mm (class 50~71) large feed-through hole in the wall with a downward slope towards the outside.
- 2 Insert a wall embedded pipe into the hole.
- 3 Insert a wall cover into the wall pipe.

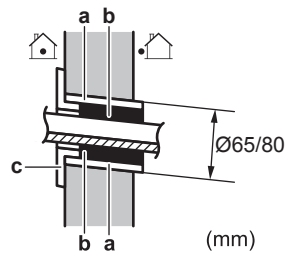

- a Wall embedded pipe  
b Putty  
c Wall hole cover

- 4 After completing wiring, refrigerant piping and drain piping, do NOT forget to seal the gap with putty.

### 6.3.3 To remove the pipe port cover



#### INFORMATION

To connect the piping on right-side, right-bottom, left-side or left-bottom, the pipe port cover MUST be removed.

- 1 Cut off the pipe port cover from inside the front grille using a coping saw.

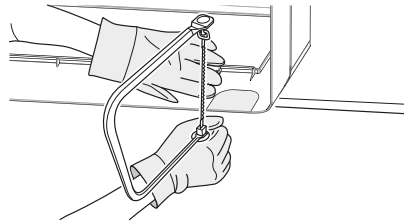

- 2 Remove any burrs along the cut section using a half round needle file.

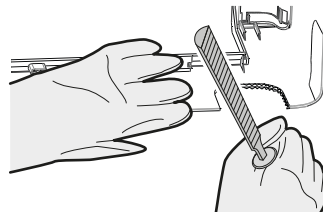

#### NOTICE

Do NOT use nippers to remove the pipe port cover, as this would damage the front grille.

## 6.4 Connecting the drain piping

In this chapter

6.4.1	General guidelines.....	27
6.4.2	To connect the piping on right side, right-back, or right-bottom.....	29
6.4.3	To connect the piping on left side, left-back, or left-bottom.....	29
6.4.4	To check for water leaks .....	30

### 6.4.1 General guidelines

- **Pipe length.** Keep drain piping as short as possible.

- **Pipe size.** If drain hose extension or embedded drain piping is required, use appropriate parts that match the hose front end.

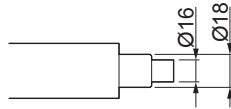

**NOTICE**

- Install the drain hose with a downward slope.
- Traps are NOT permitted.
- Do NOT put the end of the hose in water.

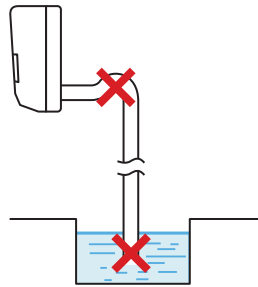

- **Drain hose extension.** To extend the drain hose, use a field supplied hose with inner Ø16 mm. Do NOT forget to use a heat insulation tube on the indoor section of the extension hose.

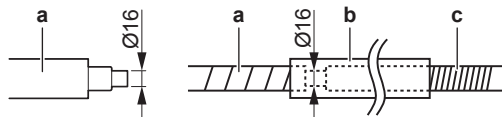

- a Drain hose supplied with the indoor unit
- b Heat insulation tube (field supply)
- c Extension drain hose

- **Ridgid polyvinyl chloride pipe.** When connecting a ridgid polyvinyl chloride pipe (nominal Ø13 mm) directly to the drain hose as with embedded piping work, use a field supplied drain socket (nominal Ø13 mm).

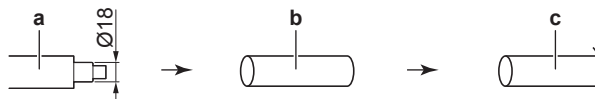

- a Drain hose supplied with the indoor unit
- b Drain socket with nominal Ø13 mm (field supply)
- c Ridgid polyvinyl chloride pipe (field supply)

- **Condensation.** Take measures against condensation. Insulate the complete drain piping in the building.

- 1 Insert the drain hose in the drain pipe as shown in the following figure, so it will NOT be pulled out of the drain pipe.

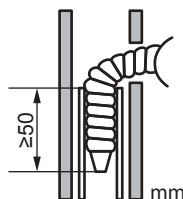

## 6.4.2 To connect the piping on right side, right-back, or right-bottom

**INFORMATION**

The factory default is right-side piping. For left-side piping, remove the piping from the right side and install it on the left side.

- 1 Attach the drain hose with adhesive vinyl tape to the bottom of the refrigerant pipes.
- 2 Wrap the drain hose and the refrigerant pipes together using insulation tape.

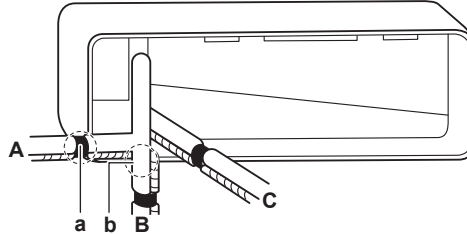

- A Right-side piping
- B Right-bottom piping
- C Right-back piping
- a Remove the pipe port cover here for right side piping
- b Remove the pipe port cover here for right-bottom piping

## 6.4.3 To connect the piping on left side, left-back, or left-bottom

**INFORMATION**

The factory default is right-side piping. For left-side piping, remove the piping from the right side and install it on the left side.

- 1 Remove the insulation fixing screw on the right side and remove the drain hose.
- 2 Remove the drain plug on the left side and attach it to the right side.

**NOTICE**

Do NOT apply lubricating oil (refrigerant oil) to the drain plug when inserting it. The drain plug may deteriorate and cause drain leakage from the plug.

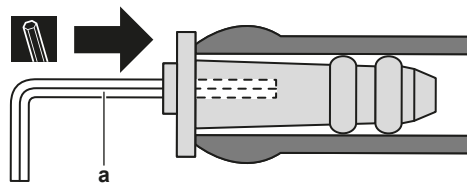

- a 4 mm hexagonal wrench

- 3 Insert the drain hose on the left side and do not forget to tighten it with the fixing screw; otherwise water leakage may occur.

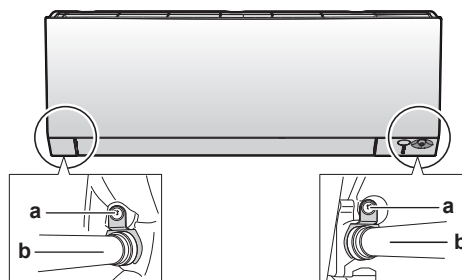

- a** Insulation fixing screw
- b** Drain hose

- 4** Attach the drain hose to the refrigerant piping bottom side using adhesive vinyl tape.

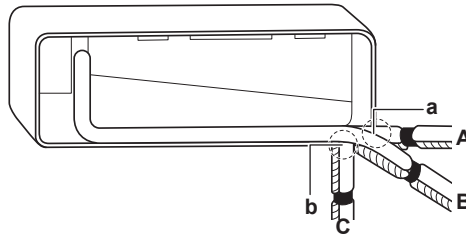

- A** Left-side piping
- B** Left-back piping
- C** Left-bottom piping
- a** Remove the pipe port cover here for left-side piping
- b** Remove the pipe port cover here for left-bottom piping

### 6.4.4 To check for water leaks

- 1** Remove the air filters.
- 2** Gradually pour approximately 1 l of water in the drain pan, and check for water leaks.

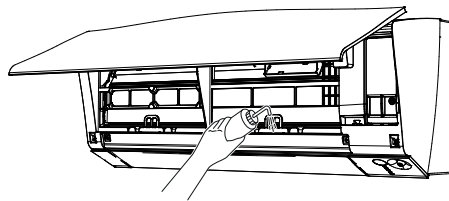

# 7 Piping installation

## In this chapter

7.1	Preparing refrigerant piping .....	31
7.1.1	Refrigerant piping requirements .....	31
7.1.2	Refrigerant piping insulation .....	32
7.2	Connecting the refrigerant piping .....	32
7.2.1	About connecting the refrigerant piping .....	32
7.2.2	Precautions when connecting the refrigerant piping .....	33
7.2.3	Guidelines when connecting the refrigerant piping .....	34
7.2.4	Pipe bending guidelines .....	34
7.2.5	To flare the pipe end .....	34
7.2.6	To connect the refrigerant piping to the indoor unit .....	35

## 7.1 Preparing refrigerant piping

### 7.1.1 Refrigerant piping requirements



#### CAUTION

Piping and joints of a split system shall be made with permanent joints when inside an occupied space except joints directly connecting the piping to the indoor units.



#### NOTICE

The piping and other pressure-containing parts shall be suitable for refrigerant. Use phosphoric acid deoxidised seamless copper for refrigerant piping.



#### INFORMATION

Also read the precautions and requirements in the "[2 General safety precautions](#)" [[7](#)].

- Foreign materials inside pipes (including oils for fabrication) must be  $\leq 30$  mg/10 m.

### Refrigerant piping diameter

Use the same diameters as the connections on the outdoor units:

Class	Pipe outer diameter (mm)	
	Liquid pipe	Gas pipe
15~42	Ø6.4	Ø9.5
50~60	Ø6.4	Ø12.7
71	Ø6.4	Ø15.9

### Refrigerant piping material

- Piping material:** phosphoric acid deoxidised seamless copper
- Flare connections:** Only use annealed material.
- Piping temper grade and thickness:**

Outer diameter ( $\varnothing$ )	Temper grade	Thickness (t) <sup>(a)</sup>	
6.4 mm (1/4")	Annealed (O)	≥0.8 mm	
9.5 mm (3/8")			
12.7 mm (1/2")			
15.9 mm (5/8")			

<sup>(a)</sup> Depending on the applicable legislation and the maximum working pressure of the unit (see "PS High" on the unit name plate), larger piping thickness might be required.

### 7.1.2 Refrigerant piping insulation

- Use polyethylene foam as insulation material:
  - with a heat transfer rate between 0.041 and 0.052 W/mK (0.035 and 0.045 kcal/mh°C)
  - with a heat resistance of at least 120°C
- Insulation thickness

Pipe outer diameter ( $\varnothing_p$ )	Insulation inner diameter ( $\varnothing_i$ )	Insulation thickness (t)
6.4 mm (1/4")	8~10 mm	≥10 mm
9.5 mm (3/8")	10~14 mm	≥13 mm
12.7 mm (1/2")	14~16 mm	≥13 mm
15.9 mm (5/8")	16~20 mm	≥13 mm

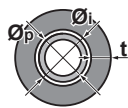

If the temperature is higher than 30°C and the humidity is higher than RH 80%, the thickness of the insulation materials should be at least 20 mm to prevent condensation on the surface of the insulation.

## 7.2 Connecting the refrigerant piping

### 7.2.1 About connecting the refrigerant piping

#### Before connecting the refrigerant piping

Make sure the outdoor and indoor unit are mounted.

#### Typical workflow

Connecting the refrigerant piping involves:

- Connecting the refrigerant piping to the indoor unit
- Connecting the refrigerant piping to the outdoor unit
- Insulating the refrigerant piping
- Keeping in mind the guidelines for:
  - Pipe bending
  - Flaring pipe ends
  - Using the stop valves



7.2.2 Precautions when connecting the refrigerant piping



**INFORMATION**

Also read the precautions and requirements in the following chapters:

- "2 General safety precautions" [▶ 7]
- "7.1 Preparing refrigerant piping" [▶ 31]



**DANGER: RISK OF BURNING/SCALDING**



**NOTICE**

- Use the flare nut fixed to the unit.
- To prevent gas leakage, apply refrigeration oil ONLY to the inside of the flare. Use refrigeration oil for R32 (FW68DA).
- Do NOT reuse joints.



**NOTICE**

- Do NOT use mineral oil on flared part.
- NEVER install a drier to this R32 unit to guarantee its lifetime. The drying material may dissolve and damage the system.



**NOTICE**

Take the following precautions on refrigerant piping into account:

- Avoid anything but the designated refrigerant to get mixed into the refrigerant cycle (e.g. air).
- Only use R32 when adding refrigerant.
- Only use installation tools (e.g. manifold gauge set) that are exclusively used for R32 installations to withstand the pressure and to prevent foreign materials (e.g. mineral oils and moisture) from mixing into the system.
- Install the piping so that the flare is NOT subjected to mechanical stress.
- Do NOT leave pipes unattended at the site. If the installation is NOT done within 1 day, protect the piping as described in the following table to prevent dirt, liquid or dust from entering the piping.
- Use caution when passing copper tubes through walls (see figure below).

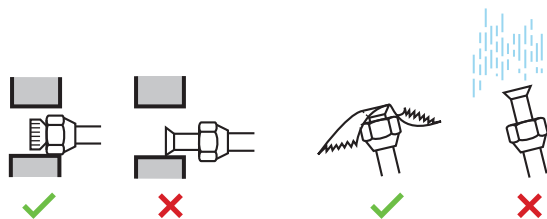

Unit	Installation period	Protection method
Outdoor unit	>1 month	Pinch the pipe
	<1 month	Pinch or tape the pipe
Indoor unit	Regardless of the period	



**NOTICE**

Do NOT open the refrigerant stop valve before checking the refrigerant piping. When you need to charge additional refrigerant it is recommended to open the refrigerant stop valve after charging.

7.2.3 Guidelines when connecting the refrigerant piping

Take the following guidelines into account when connecting pipes:

- Coat the flare inner surface with ether oil or ester oil when connecting a flare nut. Tighten 3 or 4 turns by hand, before tightening firmly.

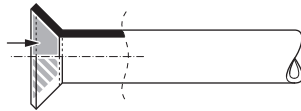

- ALWAYS use 2 wrenches together when loosening a flare nut.
- ALWAYS use a spanner and torque wrench together to tighten the flare nut when connecting the piping. This to prevent nut cracking and leaks.

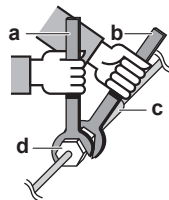

- a Torque wrench
- b Spanner
- c Piping union
- d Flare nut

Piping size (mm)	Tightening torque (N•m)	Flare dimensions (A) (mm)	Flare shape (mm)
∅6.4	15~17	8.7~9.1	
∅9.5	33~39	12.8~13.2	
∅12.7	50~60	16.2~16.6	
∅15.9	62~75	19.3~19.7	

7.2.4 Pipe bending guidelines

Use a pipe bender for bending. All pipe bends should be as gentle as possible (bending radius should be 30~40 mm or larger).

7.2.5 To flare the pipe end



**CAUTION**

- Incomplete flaring may cause refrigerant gas leakage.
- Do NOT re-use flares. Use new flares to prevent refrigerant gas leakage.
- Use flare nuts that are included with the unit. Using different flare nuts may cause refrigerant gas leakage.

- 1 Cut the pipe end with a pipe cutter.
- 2 Remove burrs with the cut surface facing down so that the chips do NOT enter the pipe.

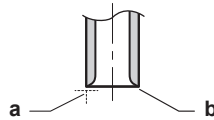

- a Cut exactly at right angles.
- b Remove burrs.

- 3 Remove the flare nut from the stop valve and put the flare nut on the pipe.
- 4 Flare the pipe. Set exactly at the position as shown in the following figure.

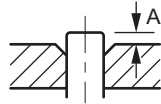

	Flare tool for R32 (clutch type)	Conventional flare tool	
		Clutch type (Ridgid-type)	Wing nut type (Imperial-type)
A	0~0.5 mm	1.0~1.5 mm	1.5~2.0 mm

- 5 Check that the flaring is properly made.

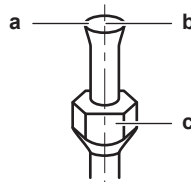

- a Flare's inner surface MUST be flawless.
- b The pipe end MUST be evenly flared in a perfect circle.
- c Make sure the flare nut is fitted.

### 7.2.6 To connect the refrigerant piping to the indoor unit



#### WARNING: MILDLY FLAMMABLE MATERIAL

The refrigerant inside this unit is mildly flammable.

- **Pipe length.** Keep refrigerant piping as short as possible.
- 1 Connect refrigerant piping to the unit using **flare connections**.
  - 2 Wrap the refrigerant piping connection using vinyl tape, overlapping at least half the width of the tape with each turn. Keep the slit of the heat insulation pipe cover up. Avoid wrapping the tape too tight.

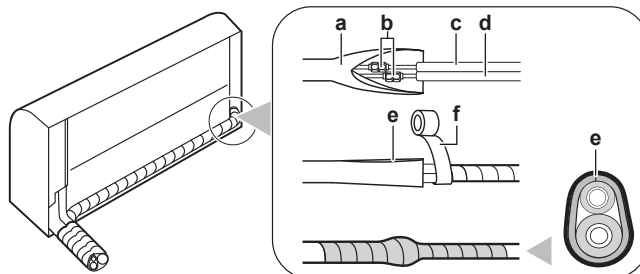

- a Heat insulation pipe cover (on the indoor unit side)
- b Flare connections
- c Liquid pipe (with insulation) (field supply)
- d Gas pipe (with insulation) (field supply)
- e Slit on heat insulation pipe cover facing up
- f Vinyl tape (field supply)

- 3 Insulate** the refrigerant piping, interconnection cable and drain hose on the indoor unit: See "[9.1 To insulate the drain piping, refrigerant piping and interconnection cable](#)" [[▶ 42](#)].

**NOTICE**

Make sure to insulate all refrigerant piping. Any exposed piping might cause condensation.

# 8 Electrical installation

## In this chapter

8.1	About connecting the electrical wiring .....	37
8.1.1	Precautions when connecting the electrical wiring .....	37
8.1.2	Guidelines when connecting the electrical wiring .....	38
8.1.3	Specifications of standard wiring components .....	39
8.2	To connect the electrical wiring to the indoor unit .....	39

## 8.1 About connecting the electrical wiring

### Before connecting the electrical wiring

Make sure the refrigerant piping is connected and checked.

### Typical workflow

Connecting the electrical wiring typically consists of the following stages:

- 1 Making sure the power supply system complies with the electrical specifications of the units.
- 2 Connecting the electrical wiring to the outdoor unit.
- 3 Connecting the electrical wiring to the indoor unit.
- 4 Connecting the main power supply.

### 8.1.1 Precautions when connecting the electrical wiring



#### DANGER: RISK OF ELECTROCUTION



#### WARNING

- All wiring **MUST** be performed by an authorised electrician and **MUST** comply with the applicable legislation.
- Make electrical connections to the fixed wiring.
- All components procured on-site and all electrical construction **MUST** comply with the applicable legislation.



#### WARNING

ALWAYS use multicore cable for power supply cables.



#### INFORMATION

Also read the precautions and requirements in the "[2 General safety precautions](#)" [[7](#)].



#### INFORMATION

Also read "[8.1.3 Specifications of standard wiring components](#)" [[39](#)].

**WARNING**

- If the power supply has a missing or wrong N-phase, equipment might break down.
- Establish proper earthing. Do NOT earth the unit to a utility pipe, surge absorber, or telephone earth. Incomplete earthing may cause electrical shock.
- Install the required fuses or circuit breakers.
- Secure the electrical wiring with cable ties so that the cables do NOT come in contact with sharp edges or piping, particularly on the high-pressure side.
- Do NOT use taped wires, stranded conductor wires, extension cords, or connections from a star system. They can cause overheating, electrical shock or fire.
- Do NOT install a phase advancing capacitor, because this unit is equipped with an inverter. A phase advancing capacitor will reduce performance and may cause accidents.

**WARNING**

Use an all-pole disconnection type breaker with at least 3 mm between the contact point gaps that provides full disconnection under overvoltage category III.

**WARNING**

If the supply cord is damaged, it MUST be replaced by the manufacturer, its service agent or similarly qualified persons in order to avoid a hazard.

**WARNING**

Do NOT connect the power supply to the indoor unit. This could result in electrical shock or fire.

**WARNING**

- Do NOT use locally purchased electrical parts inside the product.
- Do NOT branch the power supply for the drain pump, etc. from the terminal block. This could result in electrical shock or fire.

**WARNING**

Keep the interconnection wiring away from copper pipes without thermal insulation as such pipes will be very hot.

### 8.1.2 Guidelines when connecting the electrical wiring

Keep the following in mind:

- If stranded conductor wires are used, install a round crimp-style terminal on the end of the wire. Place the round crimp-style terminal on the wire up to the covered part and fasten the terminal with the appropriate tool.

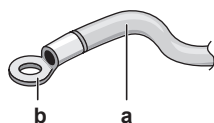

- a** Stranded conductor wire
- b** Round crimp-style terminal

- Use the following methods for installing wires:

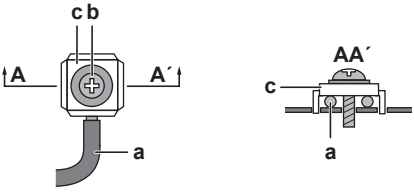
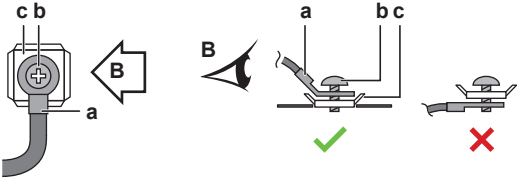
Wire type	Installation method
Single-core wire	 <p><b>a</b> Curled single-core wire  <b>b</b> Screw  <b>c</b> Flat washer</p>
Stranded conductor wire with round crimp-style terminal	 <p><b>a</b> Terminal  <b>b</b> Screw  <b>c</b> Flat washer  ✓ Allowed  ✗ NOT allowed</p>

- The earth wire between the wire retainer and the terminal must be longer than the other wires.

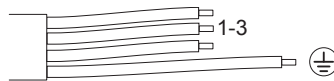

### 8.1.3 Specifications of standard wiring components

Component	
Interconnection cable (indoor↔outdoor)	4-core cable 1.5 mm <sup>2</sup> ~2.5 mm <sup>2</sup> and applicable for 220~240 V H05RN-F (60245 IEC 57)

## 8.2 To connect the electrical wiring to the indoor unit



### WARNING

Provide adequate measures to prevent that the unit can be used as a shelter by small animals. Small animals that make contact with electrical parts can cause malfunctions, smoke or fire.



### NOTICE

- Keep the power line and transmission line apart from each other. Transmission wiring and power supply wiring may cross, but may NOT run parallel.
- In order to avoid any electrical interference, the distance between both wirings should ALWAYS be at least 50 mm.

Electrical work should be carried out in accordance with the installation manual and the national electrical wiring rules or code of practice.

- 1 Set the indoor unit on the mounting plate hooks. Use the "Δ" marks as a guide.

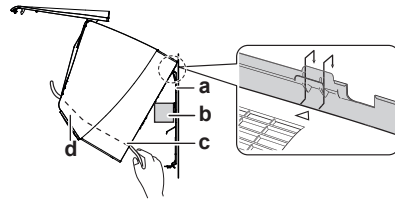

- a Mounting plate (accessory)
- b Piece of packing material
- c Interconnection cable
- d Wire guide



**INFORMATION**

Support the unit using a piece of packing material.

**Example:**

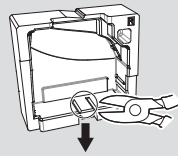

- 2 Open the front panel, and then the service cover. Refer to "6.2 Opening the unit" [▶ 23].
- 3 Pass the interconnection cable from the outdoor unit through the feed-through wall hole, through the back of the indoor unit and through the front side.

**Note:** In case the interconnection cable was stripped in advance, cover the ends with insulating tape.

- 4 Bend the end of the cable up.

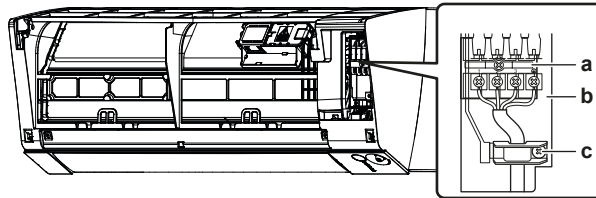

- a Terminal block
- b Electrical component block
- c Cable clamp

- 5 Strip the wire ends approximately 15 mm.
- 6 Match wire colours with terminal numbers on the indoor unit terminal blocks and firmly screw the wires to the corresponding terminals.
- 7 Connect the earth wire to the corresponding terminal.
- 8 Firmly fix the wires with the terminal screws.
- 9 Pull the wires to make sure that they are securely attached, then retain the wires with the wire retainer.
- 10 Shape the wires so that the service cover fits securely, then close the service cover.



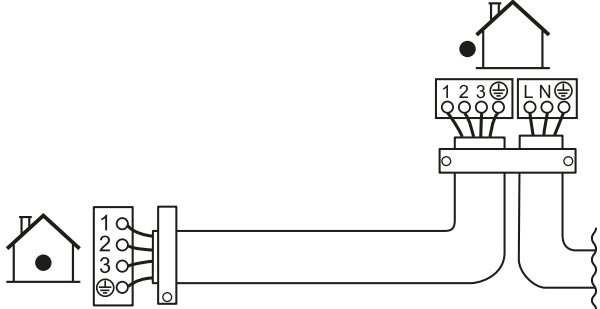

## 9 Finishing the indoor unit installation

### 9.1 To insulate the drain piping, refrigerant piping and interconnection cable

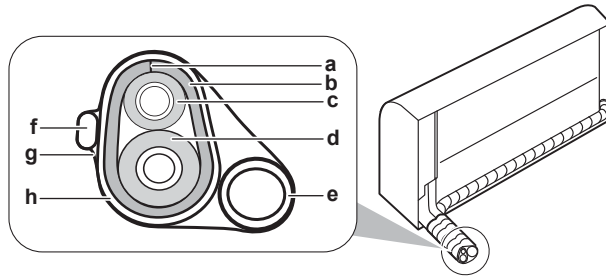

- a Slit
- b Heat insulation pipe cover
- c Liquid pipe
- d Gas pipe
- e Drain pipe
- f Interconnection wire
- g Insulation tape
- h Vinyl tape

- 1 After the drain piping, refrigerant piping and the electrical wiring are finished. Wrap refrigerant piping, interconnection cable and drain hose together using insulation tape. Overlap at least half the width of the tape with each turn.

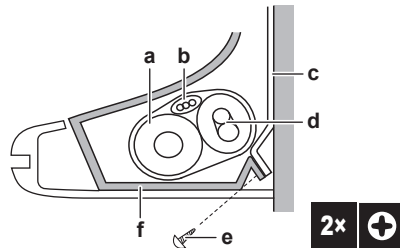

- a Drain hose
- b Interconnection cable
- c Mounting plate (accessory)
- d Refrigerant piping
- e Indoor unit fixing screw M4×12L (accessory)
- f Bottom frame

### 9.2 To pass the pipes through the wall hole

- 1 Shape the refrigerant pipes along the pipe path marking on the mounting plate.

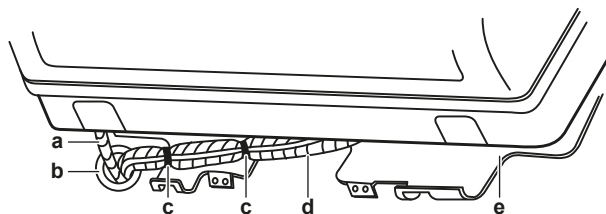

- a Drain hose
- b Caulk this hole with putty or caulking material
- c Adhesive vinyl tape
- d Insulation tape
- e Mounting plate (accessory)

**NOTICE**

- Do NOT bend refrigerant pipes.
- Do NOT push the refrigerant pipes onto the bottom frame or the front grille.

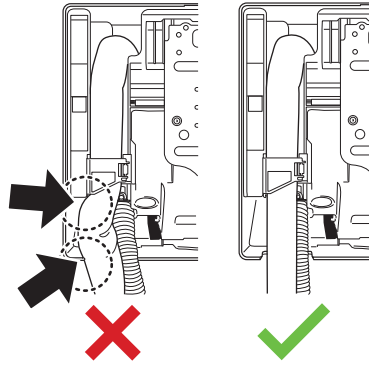

- 2 Pass the drain hose and refrigerant piping through the wall hole and seal the gap with a putty.

### 9.3 To fix the unit on the mounting plate

- 1 Set the indoor unit on the mounting plate hooks. Use the "Δ" marks as a guide.

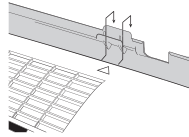

- 2 Press the bottom frame of the unit with both hands to set it on the bottom hooks of the mounting plate. Make sure that the wires do NOT get squeezed anywhere.

**Note:** Take care that the interconnection cable does NOT get caught in the indoor unit.

- 3 Press the bottom edge of the indoor unit with both hands until it is firmly caught by the mounting plate hooks.
- 4 Secure the indoor unit to the mounting plate using 2 indoor unit fixing screws M4×12L (accessory).

### 9.4 Closing the unit

#### 9.4.1 To re-install the front grille

- 1 Install the front grille and firmly engage the 3 upper hooks.
- 2 Install 2 screws (class 15~42) or 3 screws (class 50~71) back on the front grille.
- 3 **For class 50~71** re-install the lower flap (horizontal blade). Connect the 2 centre connection points. Hook the right side of the blade to the shaft. Hook the blade on its left side.
- 4 Install the air filter, mount the front panel and close it.

### 9.4.2 To close the service cover

- 1 Place the service cover to its original place on the unit.
- 2 Install 1 screw back on the service cover.



#### NOTICE

When closing the service cover, make sure that the tightening torque does NOT exceed 1.4 ( $\pm 0.2$ ) N•m.

### 9.4.3 To re-install the front panel

- 1 Attach the front panel. Align the shafts with the slots and push them all the way in.
- 2 Close the front panel slowly; press at both sides and at the centre.

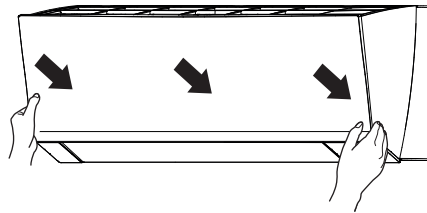

# 10 Configuration

## 10.1 To set a different channel of the indoor unit infrared signal receiver

In case 2 indoor units are installed in 1 room, different addresses for 2 user interfaces can be set.

- 1 Remove the cover and the batteries from the user interface.
- 2 Cut the address jumper J4.

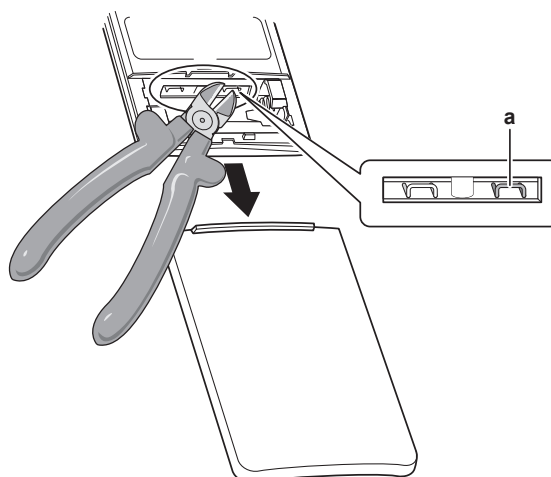





a Address jumper J4



### NOTICE

Be careful NOT to damage any of the surrounding parts when cutting the address jumper.

- 3 Turn the power supply on.
- 4 Press  and  simultaneously.
- 5 Press , select  and press .

**Result:** The operation lamp will start to blink.

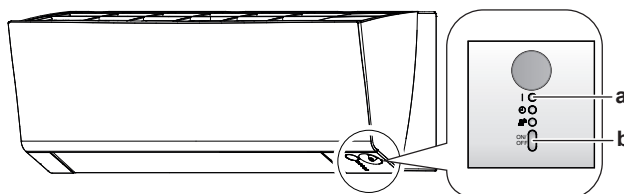

a Operation lamp  
b Indoor unit ON/OFF switch

- 6 Press the indoor unit ON/OFF switch while the operation lamp is blinking.

Address jumper	Address
Factory setting	1
After cutting with nippers	2



### INFORMATION

If the setting could NOT be completed while the operation lamp was blinking, repeat the setting process from the beginning.

**7** When the setting is complete, keep  pressed for at least 5 seconds.

**Result:** The user interface will return to the previous screen.

# 11 Commissioning



## NOTICE

**General commissioning checklist.** Next to the commissioning instructions in this chapter, a general commissioning checklist is also available on the Daikin Business Portal (authentication required).

The general commissioning checklist is complementary to the instructions in this chapter and can be used as a guideline and reporting template during commissioning and hand-over to the user.

## 11.1 Overview: Commissioning

This chapter describes what you have to do and know to commission the system after it is installed.

### Typical workflow

Commissioning typically consists of the following stages:

- 1 Checking the "Checklist before commissioning".
- 2 Performing a test run for the system.

## 11.2 Checklist before commissioning

- 1 After the installation of the unit, check the items listed below.
- 2 Close the unit.
- 3 Power up the unit.

<input type="checkbox"/>	You read the complete installation instructions, as described in the <b>installer reference guide</b> .
<input type="checkbox"/>	The <b>indoor units</b> are properly mounted.
<input type="checkbox"/>	The <b>outdoor unit</b> is properly mounted.
<input type="checkbox"/>	<b>Air inlet/outlet</b> Check that the air inlet and outlet of the unit is NOT obstructed by paper sheets, cardboard, or any other material.
<input type="checkbox"/>	There are NO <b>missing phases</b> or <b>reversed phases</b> .
<input type="checkbox"/>	The <b>refrigerant pipes</b> (gas and liquid) are thermally insulated.
<input type="checkbox"/>	<b>Drainage</b> Make sure drainage flows smoothly. <b>Possible consequence:</b> Condensate water might drip.
<input type="checkbox"/>	The system is properly <b>earthed</b> and the earth terminals are tightened.
<input type="checkbox"/>	The <b>fuses</b> or locally installed protection devices are installed according to this document, and have NOT been bypassed.
<input type="checkbox"/>	The <b>power supply voltage</b> matches the voltage on the identification label of the unit.
<input type="checkbox"/>	The specified wires are used for the <b>interconnection cable</b> .
<input type="checkbox"/>	The indoor unit receives the signals of the <b>user interface</b> .

<input type="checkbox"/>	There are NO <b>loose connections</b> or damaged electrical components in the switch box.
<input type="checkbox"/>	The <b>insulation resistance</b> of the compressor is OK.
<input type="checkbox"/>	There are NO <b>damaged components</b> or <b>squeezed pipes</b> on the inside of the indoor and outdoor units.
<input type="checkbox"/>	There are NO <b>refrigerant leaks</b> .
<input type="checkbox"/>	The correct pipe size is installed and the <b>pipes</b> are properly insulated.
<input type="checkbox"/>	The <b>stop valves</b> (gas and liquid) on the outdoor unit are fully open.

### 11.3 To perform a test run







**Prerequisite:** Power supply MUST be in the specified range.

**Prerequisite:** Test run may be performed in cooling or heating mode.

**Prerequisite:** Test run should be performed in accordance with the operation manual of the indoor unit to make sure that all functions and parts are working properly.

- 1 In cooling mode, select the lowest programmable temperature. In heating mode, select the highest programmable temperature. Test run can be disabled if necessary.
- 2 When the test run is finished, set the temperature to a normal level. In cooling mode: 26~28°C, in heating mode: 20~24°C.
- 3 The system stops operating 3 minutes after the unit is turned OFF.

#### 11.3.1 To perform a test run using the wireless remote control

- 1 Press  to switch the system on.
- 2 Press  and  simultaneously.
- 3 Press , select  and press .

**Result:** Test run operation will stop automatically after about 30 minutes.

- 4 To stop operation sooner, press .



## 12 Hand-over to the user

Once the test run is finished and the unit operates properly, make sure the following is clear for the user:

- Make sure that the user has the printed documentation and ask him/her to keep it for future reference. Inform the user that he can find the complete documentation at the URL mentioned earlier in this manual.
- Explain the user how to properly operate the system and what to do in case of problems.
- Show the user what to do for the maintenance of the unit.

# 13 Disposal



## NOTICE

Do NOT try to dismantle the system yourself: dismantling of the system, treatment of the refrigerant, oil and other parts **MUST** comply with applicable legislation. Units **MUST** be treated at a specialised treatment facility for reuse, recycling and recovery.

# 14 Technical data

















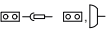

- A **subset** of the latest technical data is available on the regional Daikin website (publicly accessible).
- The **full set** of latest technical data is available on the Daikin Business Portal (authentication required).

## 14.1 Wiring diagram

**The wiring diagram is delivered with the unit, located on the inner right side of the indoor unit front grille.**

### 14.1.1 Unified wiring diagram legend

For applied parts and numbering, refer to the wiring diagram on the unit. Part numbering is by Arabic numbers in ascending order for each part and is represented in the overview below by "\*" in the part code.

Symbol	Meaning	Symbol	Meaning
	Circuit breaker		Protective earth
			
			
	Connection		Protective earth (screw)
	Connector		Rectifier
	Earth		Relay connector
	Field wiring		Short-circuit connector
	Fuse		Terminal
	Indoor unit		Terminal strip
	Outdoor unit		Wire clamp
	Residual current device		

Symbol	Colour	Symbol	Colour
BLK	Black	ORG	Orange
BLU	Blue	PNK	Pink
BRN	Brown	PRP, PPL	Purple
GRN	Green	RED	Red
GRY	Grey	WHT	White
SKY BLU	Sky blue	YLW	Yellow

Symbol	Meaning
A*P	Printed circuit board
BS*	Pushbutton ON/OFF, operation switch

Symbol	Meaning
BZ, H*O	Buzzer
C*	Capacitor
AC*, CN*, E*, HA*, HE*, HL*, HN*, HR*, MR*_A, MR*_B, S*, U, V, W, X*A, K*R_*, NE	Connection, connector
D*, V*D	Diode
DB*	Diode bridge
DS*	DIP switch
E*H	Heater
FU*, F*U, (for characteristics, refer to PCB inside your unit)	Fuse
FG*	Connector (frame ground)
H*	Harness
H*P, LED*, V*L	Pilot lamp, light emitting diode
HAP	Light emitting diode (service monitor green)
HIGH VOLTAGE	High voltage
IES	Intelligent eye sensor
IPM*	Intelligent power module
K*R, KCR, KFR, KHuR, K*M	Magnetic relay
L	Live
L*	Coil
L*R	Reactor
M*	Stepper motor
M*C	Compressor motor
M*F	Fan motor
M*P	Drain pump motor
M*S	Swing motor
MR*, MRCW*, MRM*, MRN*	Magnetic relay
N	Neutral
n=*, N=*	Number of passes through ferrite core
PAM	Pulse-amplitude modulation
PCB*	Printed circuit board
PM*	Power module
PS	Switching power supply
PTC*	PTC thermistor
Q*	Insulated gate bipolar transistor (IGBT)
Q*C	Circuit breaker

Symbol	Meaning
Q*DI, KLM	Earth leak circuit breaker
Q*L	Overload protector
Q*M	Thermo switch
Q*R	Residual current device
R*	Resistor
R*T	Thermistor
RC	Receiver
S*C	Limit switch
S*L	Float switch
S*NG	Refrigerant leak detector
S*NPH	Pressure sensor (high)
S*NPL	Pressure sensor (low)
S*PH, HPS*	Pressure switch (high)
S*PL	Pressure switch (low)
S*T	Thermostat
S*RH	Humidity sensor
S*W, SW*	Operation switch
SA*, F1S	Surge arrester
SR*, WLU	Signal receiver
SS*	Selector switch
SHEET METAL	Terminal strip fixed plate
T*R	Transformer
TC, TRC	Transmitter
V*, R*V	Varistor
V*R	Diode bridge, Insulated-gate bipolar transistor (IGBT) power module
WRC	Wireless remote controller
X*	Terminal
X*M	Terminal strip (block)
Y*E	Electronic expansion valve coil
Y*R, Y*S	Reversing solenoid valve coil
Z*C	Ferrite core
ZF, Z*F	Noise filter

# 15 Glossary

**Dealer**

Sales distributor for the product.

**Authorised installer**

Technical skilled person who is qualified to install the product.

**User**

Person who is owner of the product and/or operates the product.

**Applicable legislation**

All international, European, national and local directives, laws, regulations and/or codes that are relevant and applicable for a certain product or domain.

**Service company**

Qualified company which can perform or coordinate the required service to the product.

**Installation manual**

Instruction manual specified for a certain product or application, explaining how to install, configure and maintain it.

**Operation manual**

Instruction manual specified for a certain product or application, explaining how to operate it.

**Maintenance instructions**

Instruction manual specified for a certain product or application, which explains (if relevant) how to install, configure, operate and/or maintain the product or application.

**Accessories**

Labels, manuals, information sheets and equipment that are delivered with the product and that need to be installed according to the instructions in the accompanying documentation.

**Optional equipment**

Equipment made or approved by Daikin that can be combined with the product according to the instructions in the accompanying documentation.

**Field supply**

Equipment NOT made by Daikin that can be combined with the product according to the instructions in the accompanying documentation.



ERC

**DAIKIN EUROPE N.V.**

Zandvoordestraat 300, B-8400 Oostende, Belgium

**DAIKIN INDUSTRIES CZECH REPUBLIC s.r.o.**

U Nové Hospody 1/1155, 301 00 Plzeň Skvrňany, Czech Republic

**DAIKIN ISITMA VE SOĞUTMA SİSTEMLERİ SAN.TİC. A.Ş.**

Gülsuyu Mahallesi, Fevzi Çakmak Caddesi, Burçak Sokak, No:20, 34848 Maltepe

İSTANBUL / TÜRKİYE

Tel: 0216 453 27 00

Faks: 0216 671 06 00

Çağrı Merkezi: 444 999 0

Web: www.daikin.com.tr

Copyright 2020 Daikin

4P518023-8M 2022.05